

Easee Base

Easee Base is a robust and weatherproof post that gives you more freedom to install the Charging Robot where it suits you best. It has four configurations that support single, dual, triple and quad charger setups, getting the maximum out of the installation. Thanks to its Power Rail connection box, it connects different posts in series, while converging all Charging Robots terminations in the same rail.

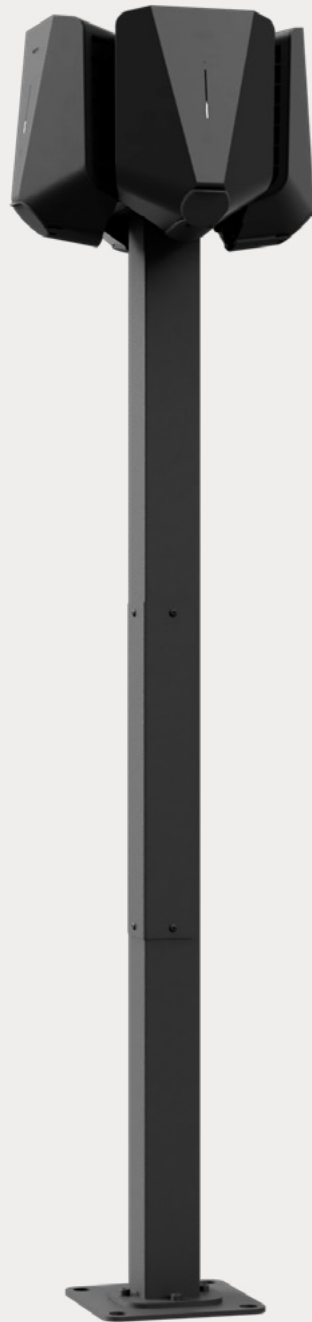

Why choose Easee Base?

Benefits

- Up to four Easee Charging Robots can be installed on the same post.
- Easy to connect each post in series with the supplied Power Rail connection box.
- Made of aluminium, with a strong scratch resistant powder coating, ensuring a long lasting durability.
- Integrated cable hooks that allow the charging cable to be permanently connected¹
- Adapter plate that allows for a 45 degree installation angle.
- Designed in Norway

¹Only available for 1-way and 2-way setups. The charging cable can be permanently locked in the Charging Robot.



Power Rail

The Power Rail is a connection box that allows multiple charging posts to be connected in series.

We recommend using the two upper terminal sets for the charger cables. For a single charger, only one set of terminals is used, for two chargers both sets of terminals are used and for three or four chargers two wires have to share a terminal.

The two lower sets of terminals are used for power in and out.

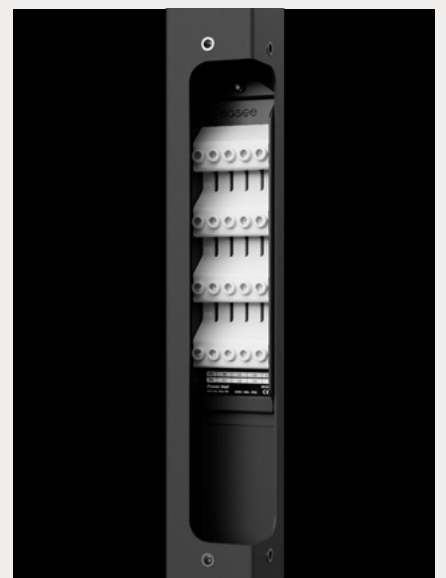

Specifications

Measurement
in mm

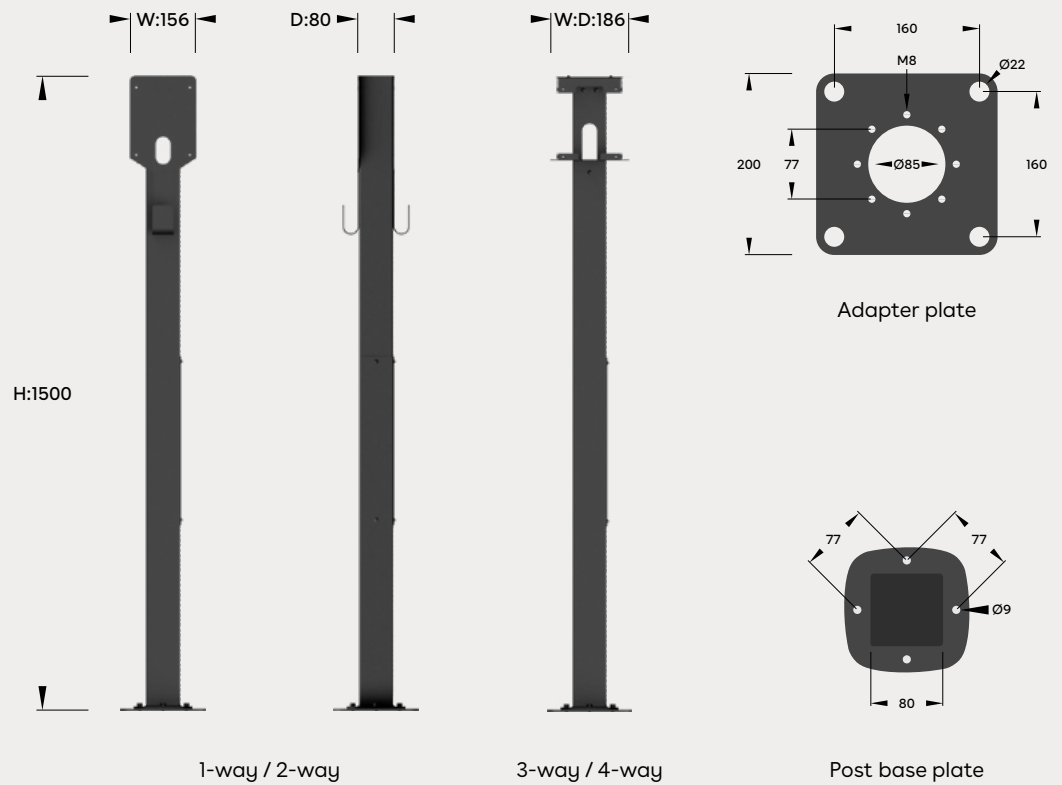

Technical

General

Dimension (mm):
1-way / 2-way: H: 1500 x W: 156 x D: 80
3-way / 4-way: H: 1500 x W: 186 x D: 186
Weight: 6.1-7.7 kg
Material: Aluminium
Finish: Powder coating
Colour: Black
Degree of protection: IP44

Features

Adapter plate for c/c 160 mm² foundation
45 degree rotation intervals (using the adapter plate)
Screws and nuts included

Electrical connection

Connection via Power Rail
Possibility of serial connection of posts

Cable size

In and out of the post: Max 25 mm²
Up to the Charging Robots : 6 mm²

Common parts

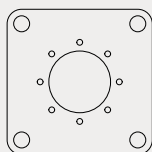

Adapter plate



Power Rail + ground connection plate



Side panel

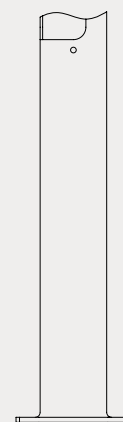

Column

1-way
Part no. 90322

2-way
Part no. 90323

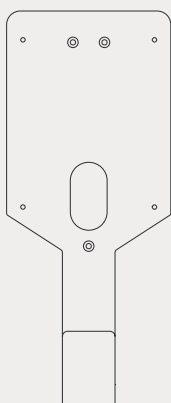

Mounting plate



1-way blind cover

3-way
Part no. 90324

4-way
Part no. 90325

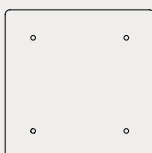

Top plate

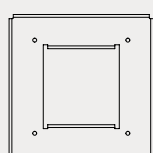

Top frame

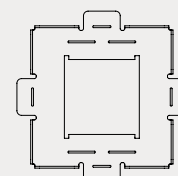

Bottom frame



3-way blind cover

THIS DOCUMENT CONTAINS INFORMATION THAT IS SUBJECT TO CHANGE WITHOUT NOTICE.

The latest version of this publication can be downloaded at <http://easee.support>

No part of this publication may be reproduced or transmitted in any form or by any means, electronic or mechanical, including, but not limited to, copying, recording, retrieving data, or computer networks without the written permission of Easee AS.

Easee and all other Easee product names and slogans are trademarks or registered trademarks of Easee AS. Easee products can be protected by one or more patents.

All other products and services mentioned may be trademarks or service marks of their respective owners.

Illustrations of the product and user interface are exemplary and may differ from the actual appearance.

October 2020 - Version 1.01
© 2018 by Easee AS. All rights reserved.



Easee AS
Grenseveien 19
4313 Sandnes, Norway
Org.nr: 920 292 046

Easee is distributed and maintained by a network of qualified partners and resellers. Find more information and your local partner at:

www.easee.com