



Connecting Strength

K2 SYSTEMS RECOMMENDATION

Equipotential Bonding and Lightning Protection for PV mounting systems



Content

General notes

Basic information	3
Equipotential bonding & earthing	4
TerraGrif earthing components	5
Lightning protection	6
Lightning protection example 1	7
Lightning protection example 2.....	8
Lightning protection example 3.....	9
Lightning protection spacing	10
Lightning current capacity of mounting systems ..	11

Pitched roofs

Tiled roof cover	12
Tiled roof cover with the prescribed frame earthing..	13
Corrugated roof covers or trapezoidal metal sheet / sandwich panels with hanger bolts or solar fasteners.....	14
Assembly with second rail layer	15
Trapezoidal metal sheet roof covers with BasicRail....	16
Trapezoidal metal sheet roof covers MiniRail.....	17
Trapezoidal metal sheet roof covers MiniFive.....	18
Trapezoidal metal sheet roof covers with MultiRail and MultiRail CSM	19
Standing seam roof covers.....	20

Flat roofs

Basic information	21
S-Dome 6 Xpress: Lightning protection	22
S-Dome 6 Xpress: Lightning protection	23
D-Dome 6 Xpress: Lightning protection	24
D-Dome 6 Xpress: Lightning protection	25
S-Dome 6 Classic: Equipotential bonding and lightning protection	26
D-Dome 6 Classic: Equipotential bonding and lightning protection.....	27
S-Dome 6 Classic LS: Equipotential bonding and lightning protection.....	28
D-Dome 6 Classic LS: Equipotential bonding and lightning protection.....	29

Components

K2 lightning protection elements	31
Basic information	31

General notes

Basic information

- Below you will find recommendations on how to establish equipotential bonding and lightning current carrying connections for various mounting systems from K2 Systems.
- K2 Systems GmbH expressly points out that the use of the components mentioned is only a recommendation. Alternatively, lightning protection components from other manufacturers can also be used.
- An existing lightning protection system must not be impaired in its effect by a PV system. In any case, the lightning protection concept must be coordinated with a lightning protection planning office or a lightning protection specialist.
- A lightning protection system to be installed must be designed in such a way that it fulfils its function even without a PV system.
- When planning and executing the connections between cables and the mounting system, permanently suitable materials must be selected, taking into account the electrochemical voltage series, in order to avoid contact corrosion. The components listed below are required in addition to the articles of the mounting system. Alternatively, additional or different connection terminals can be obtained directly from specialist suppliers.
- With regard to planning and execution, the national and local standards must be observed. We would like to point out that the recommendation was prepared on the basis of German standards.
- Requirements with regard to planning can be found in the relevant standards.
- Recommendations or installation instructions of the module manufacturer must be observed.
- Normatively, module frame earthing is not required. Exceptions exist if the module manufacturer specifies frame earthing, which is increasingly the case. We therefore recommend checking the installation instructions of the module. If necessary, each module frame must be included in the equipotential bonding!
- Equipotential bonding should ideally be installed in such a way that modules can be removed from the layout in the event of service without the equipotential bonding losing its function.

General information

Equipotential bonding & earthing

- If points are conductively interconnected to varying potentials, the potential difference between them is balanced out. The electrical voltage between the points can no longer be measured, thus establishing equipotential bonding.
- The connection of a point on the electrical system to the ground is called earthing. This can fulfil certain tasks, such as
 - Lightning protection
 - Ensuring electromagnetic compatibility
 - Protective or functional earthing of certain equipment, such as power inverters
- Equipotential bonding and an earthing system complement each other to form an effective protection system
- Equipotential bonding must always be added to PV systems in accordance with VDE 0100. This applies to all conductive and exposed components.

Equipotential bonding

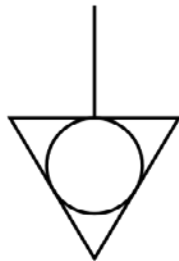

Earthing

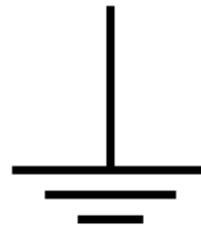

TerraGrif Erdungskomponenten

- TerraGrif earthing system:
- Simple and fast module earthing solution for all K2 mounting systems
- Complies with the earthing provisions in the standards NF C 15-100 and the guide UTE C15-712-1
- Tested and approved by LCIE Bureau Veritas
- Attention: For technical reasons, a TerraGrif cannot be used again after it has been used once and removed again.
- Please also observe the TerraGrif assembly instructions k2-systems.com/en/terragrif

Overview of TerraGrif



	K2SZ	U17	K2MI Duo 18	PL	K2PA	QL	S Insertionsystem
Image							
Compatibility							
SingleRail	●	○	○	○	○	●	○
SolidRail	●	○	○	○	○	●	○
Insertionsystem	○	○	○	○	○	○	●
BasicRail	●	○	○	○	●*	●	○
MiniRail	●	○	○	○	○	●	○
MultiRail	●	○	○	○	○	●	○
D-/S-Dome	●	○	○	○	○	●	○
D-/S-Dome V	○	○	●	○	○	○	○
D-/S-Dome 6	○	○	●	●	○	○	○
Item number	2001881	2000056	2003542	2004102	2000055	2004231	2002397
Std. tolerance value	Norm DIN 2095 grade 2						
Material	Stainless steel 301 TA						
Norm	NFA 35573						
Weight [g]	3,2	1,8	3,6	1,15	2,4	4,2	1,5
Dim. W × H × D [mm]	10 × 16 × 60	20 × 5,8 × 17	40 × 11,7 × 36	22 × 10 × 8	10 × 31,7 × 12	17,5 × 9 × 45	10 × 13,5 × 21
Thickness [mm]	0,5						

● Compatible ○ Not tested ○ Not compatible

* Only for landscape assembly with AddOn.

For equipotential bonding of the S-Dome Classic and D-Dome Classic systems, we recommend using the TerraGrif U17. Check the geometry of the module frame beforehand. The TerraGrif U17 cannot be used with a rounded module frame underside (see graphic). In this case, we recommend using the TerraGrif K2SZ as an alternative for the dome systems. If it is unclear which TerraGrif you need to use, please contact Technical Support at the e-mail address: service@k2-systems.com

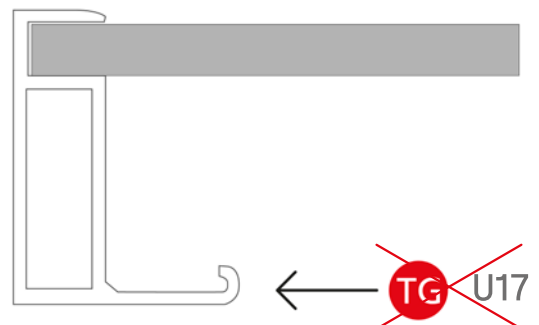

General information



Lightning protection

- A lightning protection system is deemed to be precautions against the adverse effects of lightning strikes on buildings.
- Due to its strong electromagnetic field, the lightning can also indirectly affect electrical cables or metal parts, such as pipes within a building, and cause damage.
- A lightning strike can cause fires.
- A lightning protection system cannot provide absolute protection.
- External lightning protection:
 - External lightning protection provides protection against lightning strikes that would directly hit the system to be protected. It consists of interception devices, lightning conductors (lightning conduction system) and an earthing system.
- Internal lightning protection:
 - The overvoltage protection, which constitutes the internal lightning protection, consists of measures against overvoltage of all kinds. The effects of a lightning strike up to about 1.5 km away are also transferred to installations as well as electrical and electronic systems within the physical structure. Internal lightning protection also protects against effects from the mains.
- Protection of property (objects) and persons

Lightning protection example 1

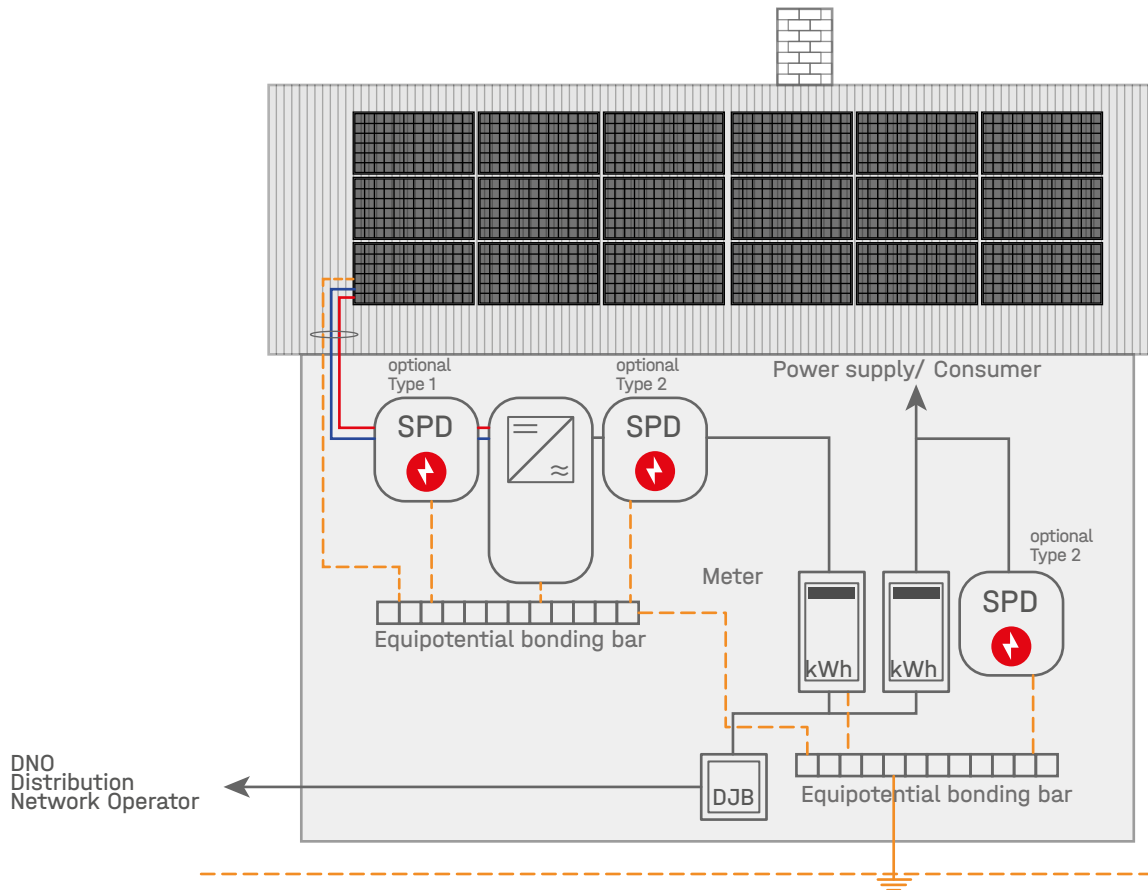
- If external lightning protection is not available, no lightning protection needs to be established for the PV system.
- The choice of overvoltage protection devices should be made in accordance with DIN EN 62305-33







-  = Domestic junction box
-  SPD (Surge Protective Device) = Overvoltage protection
-  = Power inverter

General information

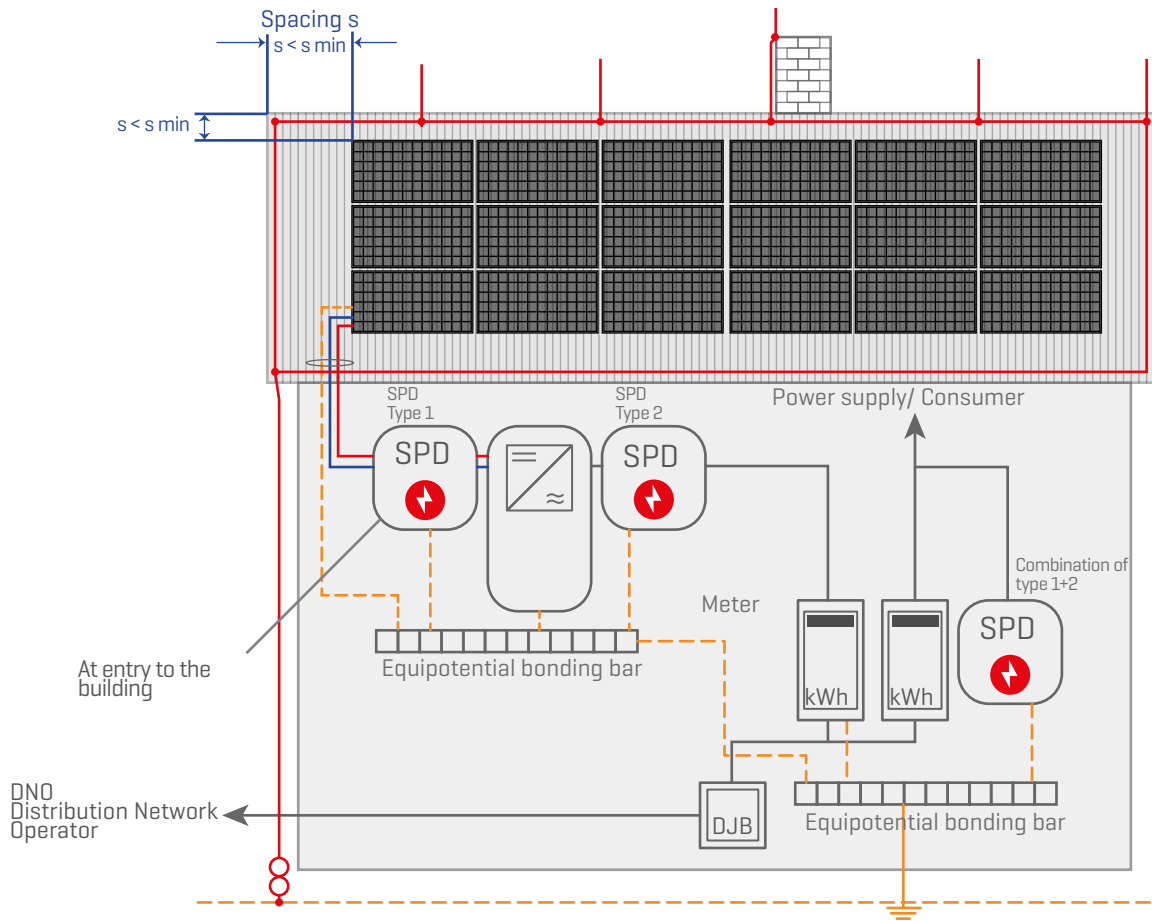
Lightning protection example 2

- External lightning protection is available, but the spacing "s" can be observed. The system is not integrated!
- Note the requirements for overvoltage protection (mains entry) in accordance with DIN EN 62305-3!



-  = domestic junction box
-  SPD (Surge Protective Device) = overvoltage protection
-  = power inverter

Lightning protection example 3

- External lightning protection is available, but the spacing "s" cannot be observed. The system is integrated!
- Note the requirements for overvoltage protection (mains entry & building entry) in accordance with DIN EN 62305-3!

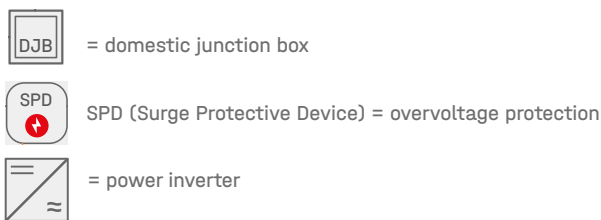
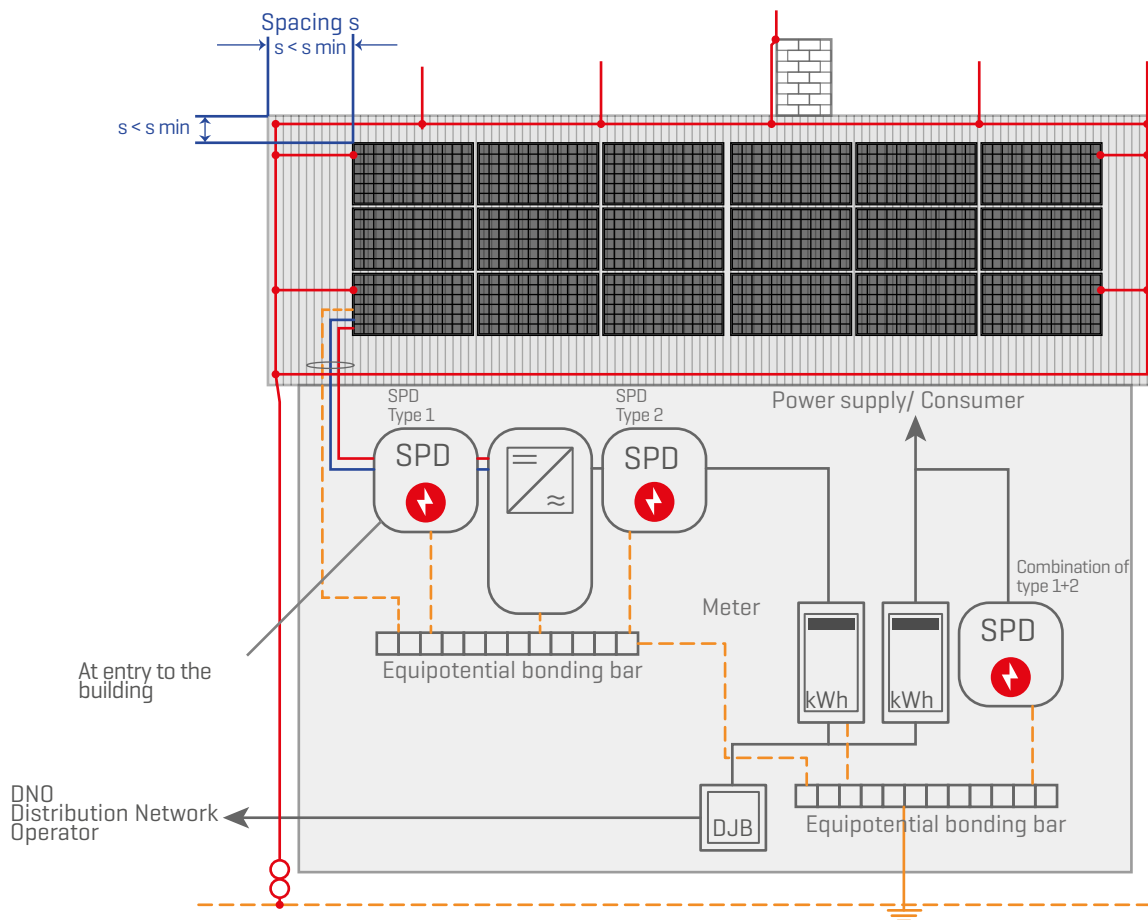

General information

Lightning protection spacing

Spacing:

- The spacing "s" is calculated using the following formula in accordance with DIN EN 62305-3. It is not a standard value!
- Typical values for "s" are between 30 and 70 cm. The empirical formula "s" = 50 cm cannot be used safely!
- Typical error in calculating "s":
The material factor for solid materials on the roof covering is $k_m = 0.5$
- Software can be used for the calculation, e.g. DEHN Distance Tool
- If the spacing is to be observed, all parts of the PV system must comply with this (modules, frame, cables, earthing))

$$s = k_i \times \frac{k_c}{k_m} \times l$$

s = spacing

k_i = induction factor (depending on the lightning protection class).

k_c = current distribution coefficient: $k_c = \frac{1}{2n} + 0.1 + 0.2 \times \sqrt{c}$

k_m = material factor: insulation properties of the environment

l_m = distance from the point of proximity, usually the distance to the foundations ("minimum distance")

** Literary reference for the calculation: DEHN Lightning Planner, Wagner & Co. Lightning Protection Guide **

Lightning current capacity of mounting systems

- If a mounting system is integrated into a building's existing external lightning protection, the connection to the mounting system must be designed in such a way that it is capable of carrying lightning current. However, as the mounting system is not used as a power output, it does not need to be capable of carrying lightning current because the existing lightning protection takes on this function.
- The mounting system needs to be capable of carrying lightning current if the mounting system replaces part of the external lightning protection.
- It is essential that the planning to integrate the system into the existing external lightning protection and therefore also the number of connections for the external lightning must be carried out by a lightning protection specialist.
- It is important to ensure that the power input and output are designed with different cross-sections depending on the function.
- We recommend a minimum cross-section of $\geq 6 \text{ mm}^2$ copper or $\geq 16 \text{ mm}^2$ aluminium for the electrical connection of the equipotential bonding.
- We recommend a minimum cross-section of $\geq 16 \text{ mm}^2$ copper or $\geq 25 \text{ mm}^2$ aluminium for the electrical connection to the lightning protection.

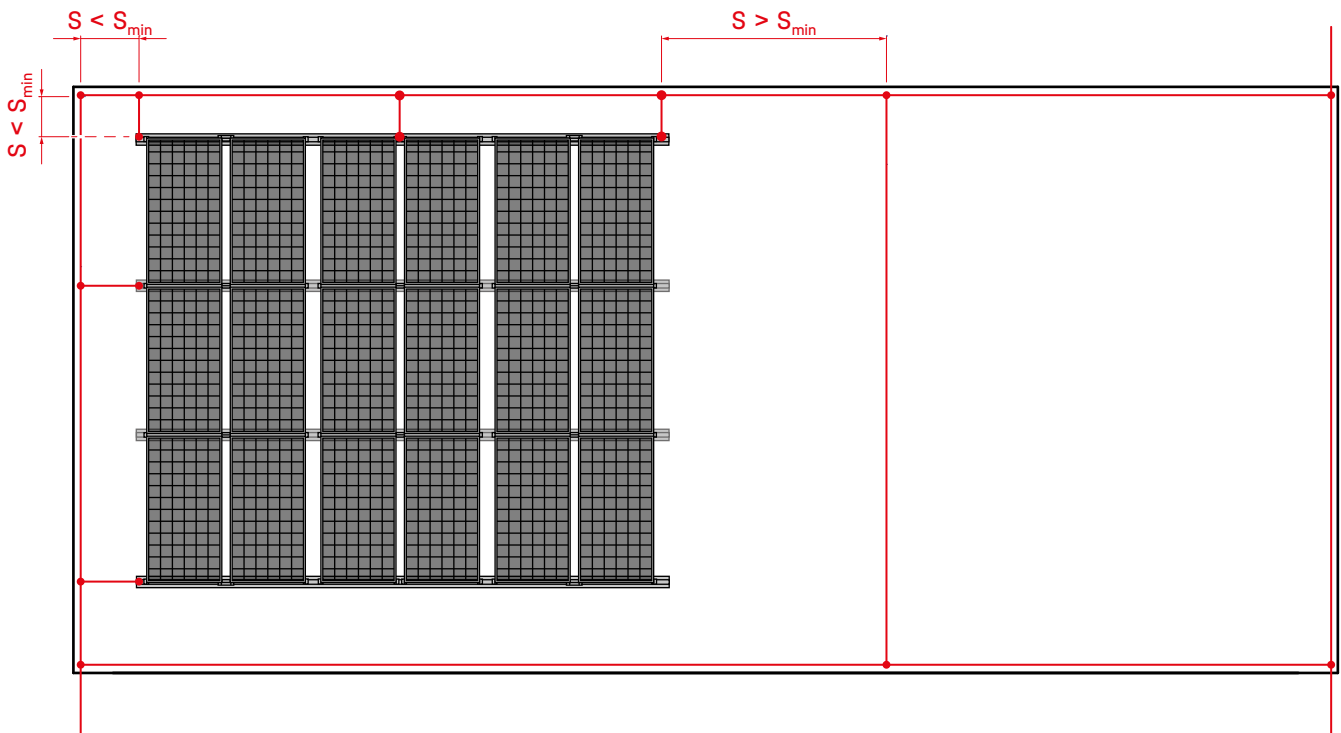

Pitched roofs

Tiled roof cover

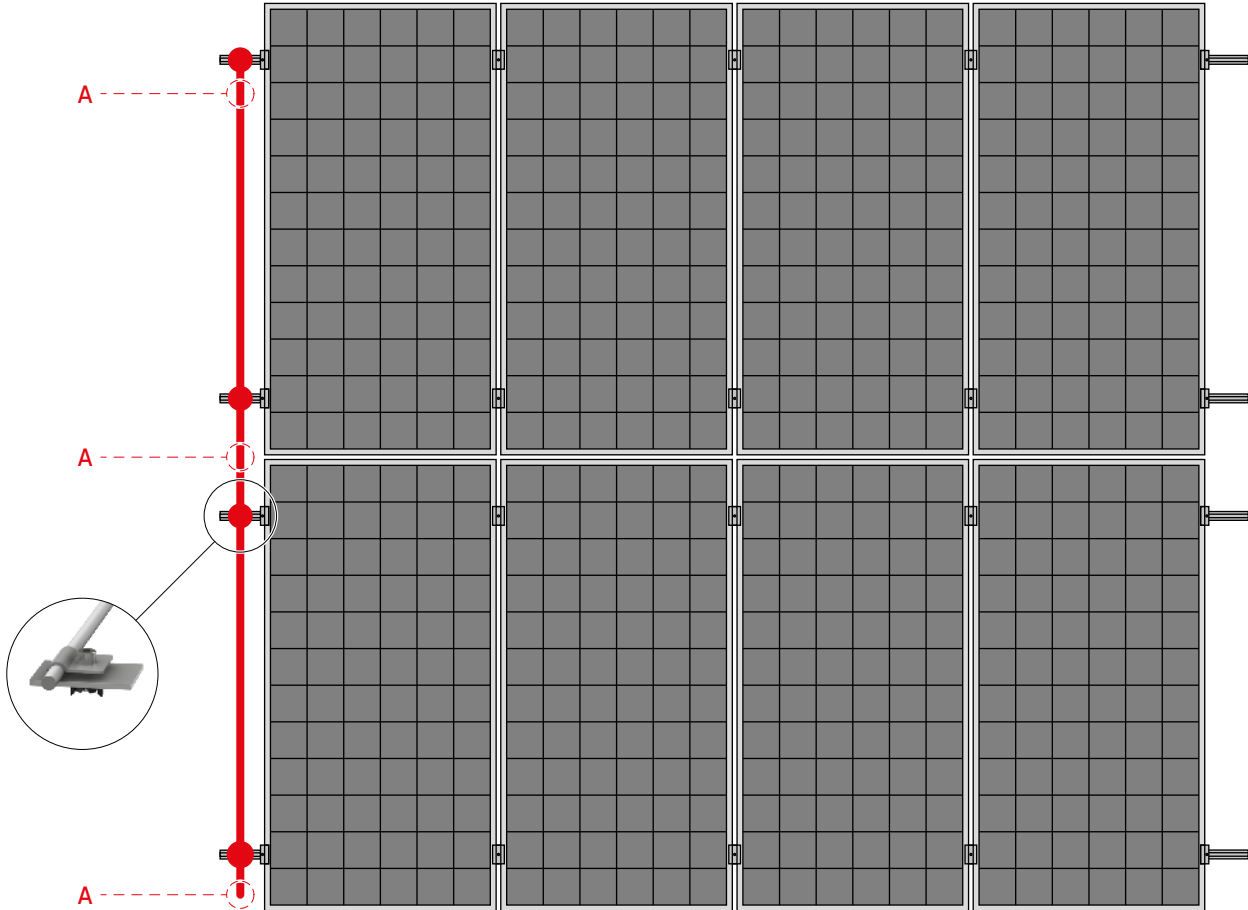

(A) Connection of equipotential bonding cable as alternative lightning protection

Lightning protection and equipotential bonding

- We recommend connecting the rails per module block with a round aluminium wire ($\geq 16 \text{ mm}^2$).
- The connection with lightning protection terminal and aluminium round wire can be made capable of carrying lightning current if required ($\geq 25 \text{ mm}^2$ aluminium round wire).
- The conductive connection must be checked; if necessary, the oxide layer of the aluminium must be ground.
- For the connection of the equipotential bonding line, only use cable lugs that are permanently suitable taking into account the electro-chemical voltage series.
- Module frame earthing is not given in this case.

Materials needed:

- **K2 Lightning protection clamp multi Alu 8 mm Set** consists of:
 - Lightning protection clamp Multi
 - Slot nut, stainless steel, PA
 - Allen Bolt M8 x 30
 - Washer 8,4x20x1,2 mm
- **Round wire**
- **K2 Underlay plate**

Tiled roof cover with the prescribed frame earthing

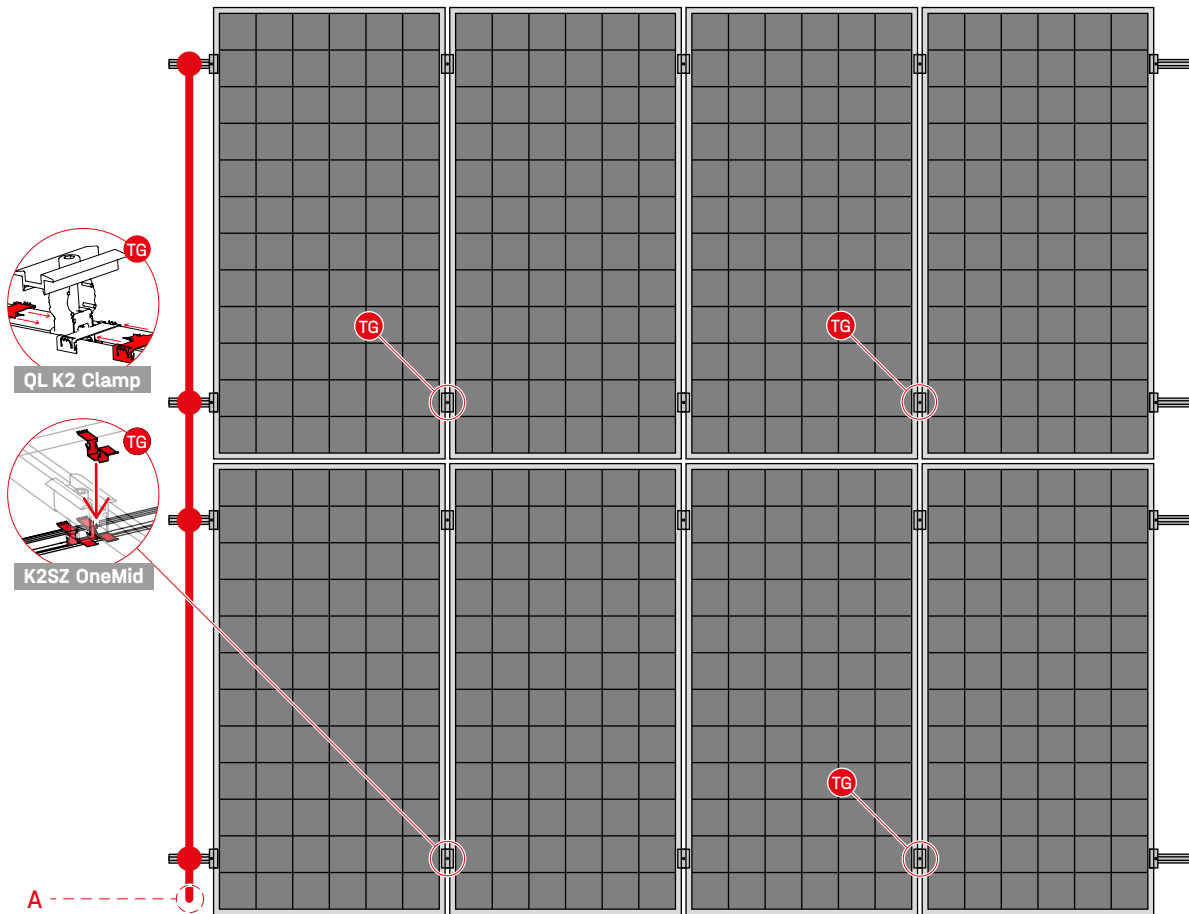

(A) Connection of the equipotential bonding cable as alternative lightning protection

Lightning protection and equipotential bonding

- If the module manufacturer specifies frame earthing, we recommend using the TerraGrifs.
- The TerraGrifs can be placed underneath the module clamp on the left or right.
- You need at least one TerraGrif per module.
- Please also note the assembly instructions for the TerraGrif k2-systems.com/en/terragrif
- When using the K2 Clamp, you need the TerraGrif QL. When using the universal and standard clamps, you need TerraGrif K2SZ.

Materials needed:

- **K2 Lightning protection clamp multi Alu 8 mm Set** consists of:
 - Lightning protection clamp Multi
 - Slot nut, stainless steel, PA
 - Allen Bolt M8 x 30
 - Washer 8,4×20×1,2 mm
- **Round wire**
- **K2 Underlay plate**
- **If necessary TerraGrif K2SZ/ TerraGrif QL**

Corrugated roof covers or trapezoidal metal sheet / sandwich panels with hanger bolts or solar fasteners

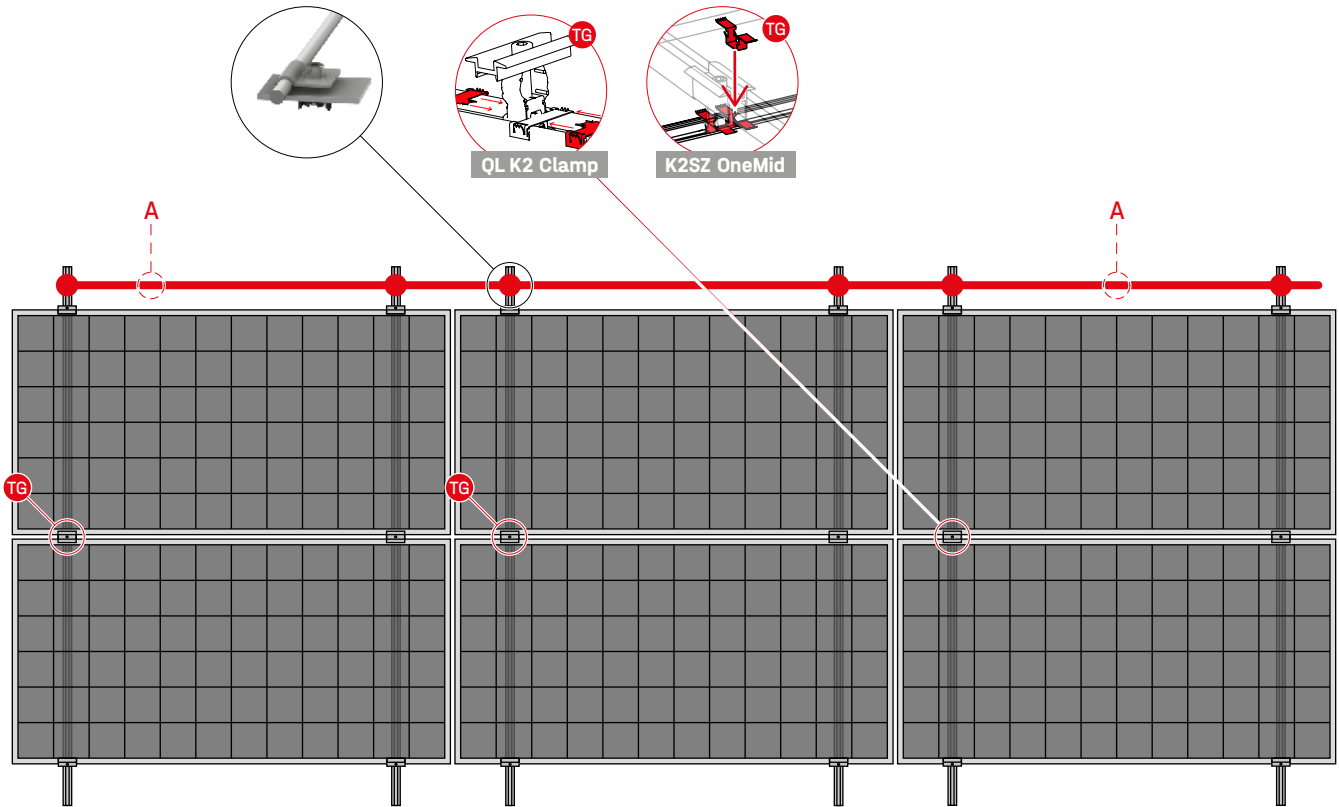

(A) Connection of the equipotential bonding cable as alternative lightning protection

Lightning protection and equipotential bonding

- When mounting with hanger bolts or solar fasteners, the procedure is the same as for a tiled roof.
- We recommend connecting the rails per module block with an aluminium round wire ($\geq 16 \text{ mm}^2$).
- The connection with lightning protection clamp and aluminium round wire can be made capable of carrying lightning current if required ($\geq 25 \text{ mm}^2$ aluminium round wire).
- In the case of a two-layer system, ensure that the rails are conductively connected.
- The use of TerraGrif according to the illustration is carried out according to the requirement of module frame earthing.
- If module frame earthing is mandatory, you need one TerraGrif per module.
- When using the K2 Clamp, you need the TerraGrif QL. When using the universal and standard clamps, you need TerraGrif K2SZ.

Materials needed:

- **K2 Lightning protection clamp multi Alu 8 mm Set** consists of:
 - Lightning protection clamp Multi
 - Slot nut, stainless steel, PA
 - Allen Bolt M8 x 30
 - Washer 8,4x20x1,2 mm
- **Round wire**
- **K2 Underlay plate**
- **If necessary TerraGrif K2SZ/ TerraGrif QL**

Assembly with second rail layer

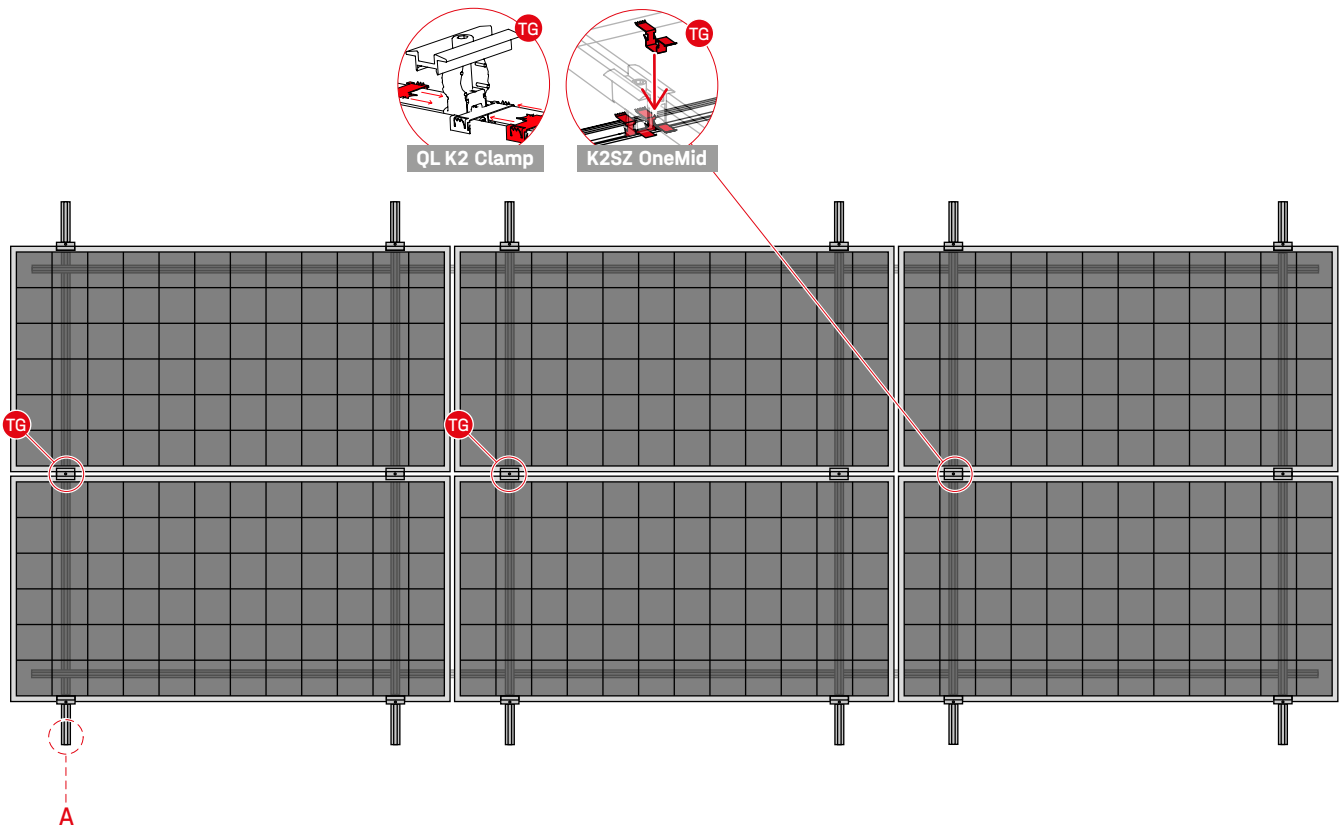

(A) Connection of the equipotential bonding cable as alternative lightning protection

Lightning protection and equipotential bonding

- With a cross-connection or two-layer rail system, an additional conductive connection of the rails can be dispensed with. However, the electrical connection of the rail layers must be ensured by removing the oxide layer at the crossing points of the rails.
- TerraGrif as shown in the illustration is used according to the need for module frame earthing.
- In the case of black anodised rails, the conductive connection of the rail layers must be made on site.
- If module frame earthing is mandatory, you need one TerraGrif per module.
- When using the K2 Clamp, you need the TerraGrif QL. When using the universal and standard clamps, you need TerraGrif K2SZ.

Materials needed:

- **K2 Lightning protection clamp multi Alu 8 mm Set** consists of:
 - Lightning protection clamp Multi
 - Slot nut, stainless steel, PA
 - Allen Bolt M8 x 30
 - Washer 8,4×20×1,2 mm
- **Round wire**
- **K2 Underlay plate**
- **If necessary TerraGrif K2SZ/ TerraGrif QL**

Trapezoidal metal sheet roof covers with BasicRail

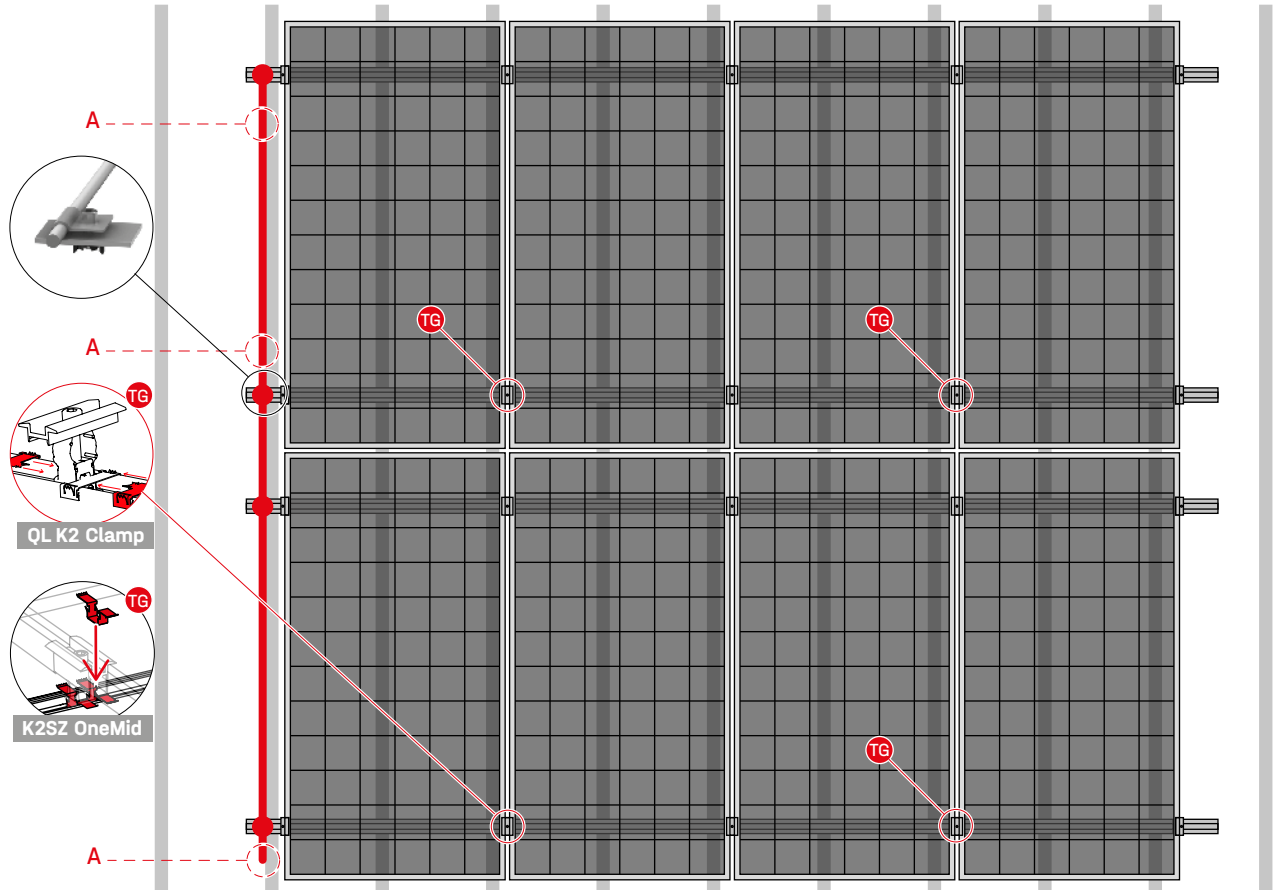

(A) Connection of the equipotential bonding cable as alternative lightning protection

Blitzschutz und Potentialausgleich

- With the BasicRail system, as with a tiled roof, there is no conductive connection via the trapezoidal sheet metal to the rails.
- We recommend connecting the rails per module block with a round aluminium wire ($\geq 16 \text{ mm}^2$).
- The connection with lightning protection clamp and aluminium round wire can be made capable of carrying lightning current if required ($\geq 25 \text{ mm}^2$ aluminium round wire).
- The use of TerraGrif according to the illustration is carried out according to the need for module frame earthing.
- When using the K2 Clamp, you need the TerraGrif QL. When using the universal and standard clamps, you need TerraGrif K2SZ.

Materials needed:

- **K2 Lightning protection clamp multi Alu 8 mm Set** consists of:
 - Lightning protection clamp Multi
 - Slot nut, stainless steel, PA
 - Allen Bolt M8 x 30
 - Washer 8,4x20x1,2 mm
- **Round wire**
- **K2 Underlay plate**
- **If necessary TerraGrif K2SZ/ TerraGrif QL**

Trapezoidal metal sheet roof covers with MiniRail/MiniRail MK2

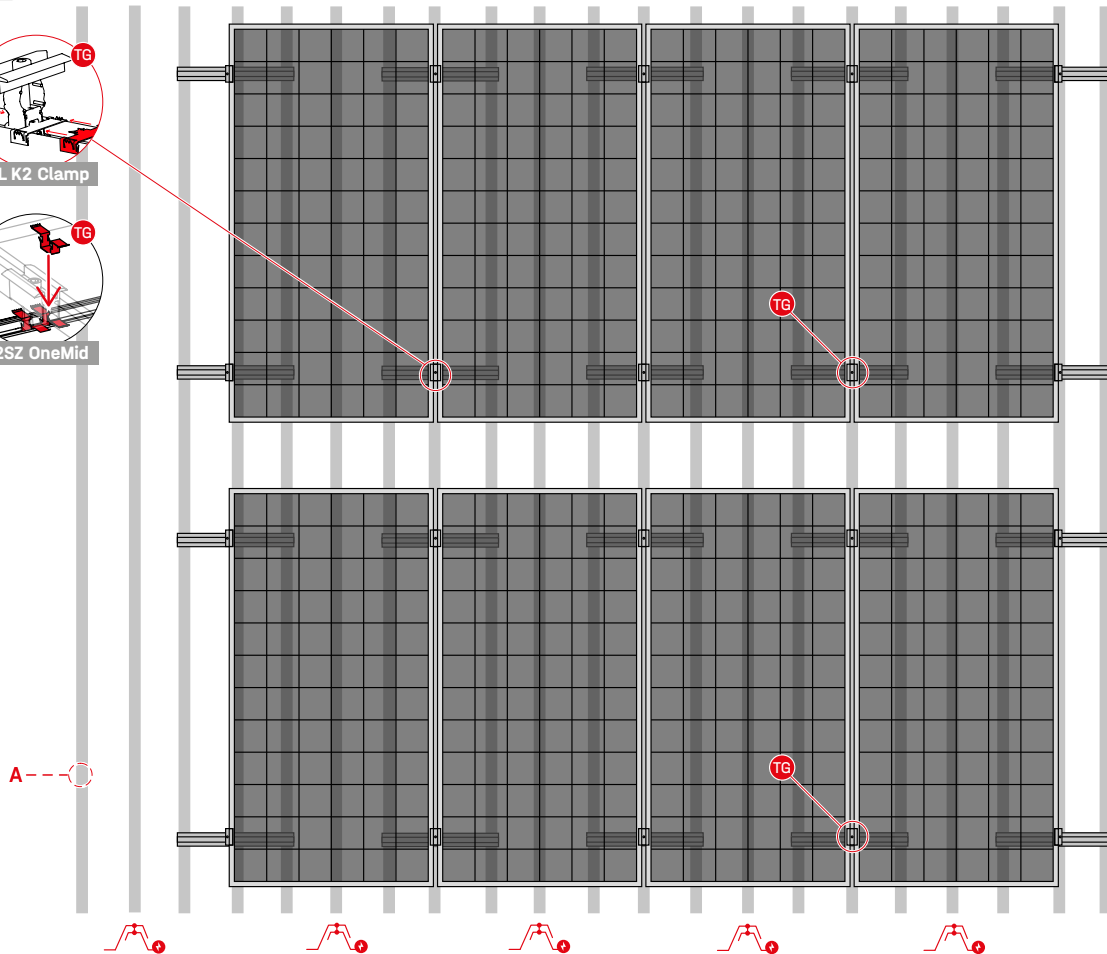
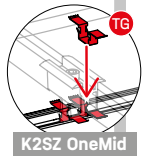
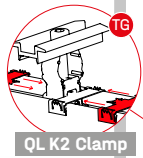

The trapezoidal sheets must be conductively connected to each other!

(A) Connection of the equipotential bonding cable as alternative lightning protection

Lightning protection and equipotential bonding

- The drill holes in the MiniRail are selected in such a way that the screws in the set will inevitably work their way into the aluminium to such an extent that an electrical connection between the sheet metal and the MiniRail is created.
- We therefore recommend providing the trapezoidal sheet metal tracks with potential equalisation. Make sure that the individual trapezoidal profiles are also electrically connected to each other.
- In this way, potential equalisation is guaranteed via the trapezoidal sheet metal.
- For a connection to an external lightning protection, all MiniRail sets may have to be connected so that they are capable of carrying lightning currents. In this case, we recommend keeping the separation distance!
- The use of TerraGrif according to the illustration is carried out according to the need for module frame earthing. Pay attention to the MiniRail type.
- When using the K2 Clamp, you need the TerraGrif QL. When using the universal and standard clamps, you need TerraGrif K2SZ.

Materials needed:

If necessary TerraGrif K2MI for MiniRail and K2SZ/TerraGrif QL for MiniRail MK2

Trapezoidal metal sheet roof covers with MiniRail MK2/MiniFive MK2

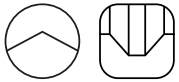

The example shows a MiniRail MK2 with MiniFive MK2, TerraGrif PL, incl. module frame earthing with TerraGrif K2SZ or TerraGrif QL.

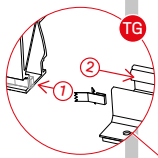
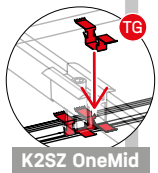
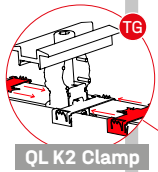

A ---

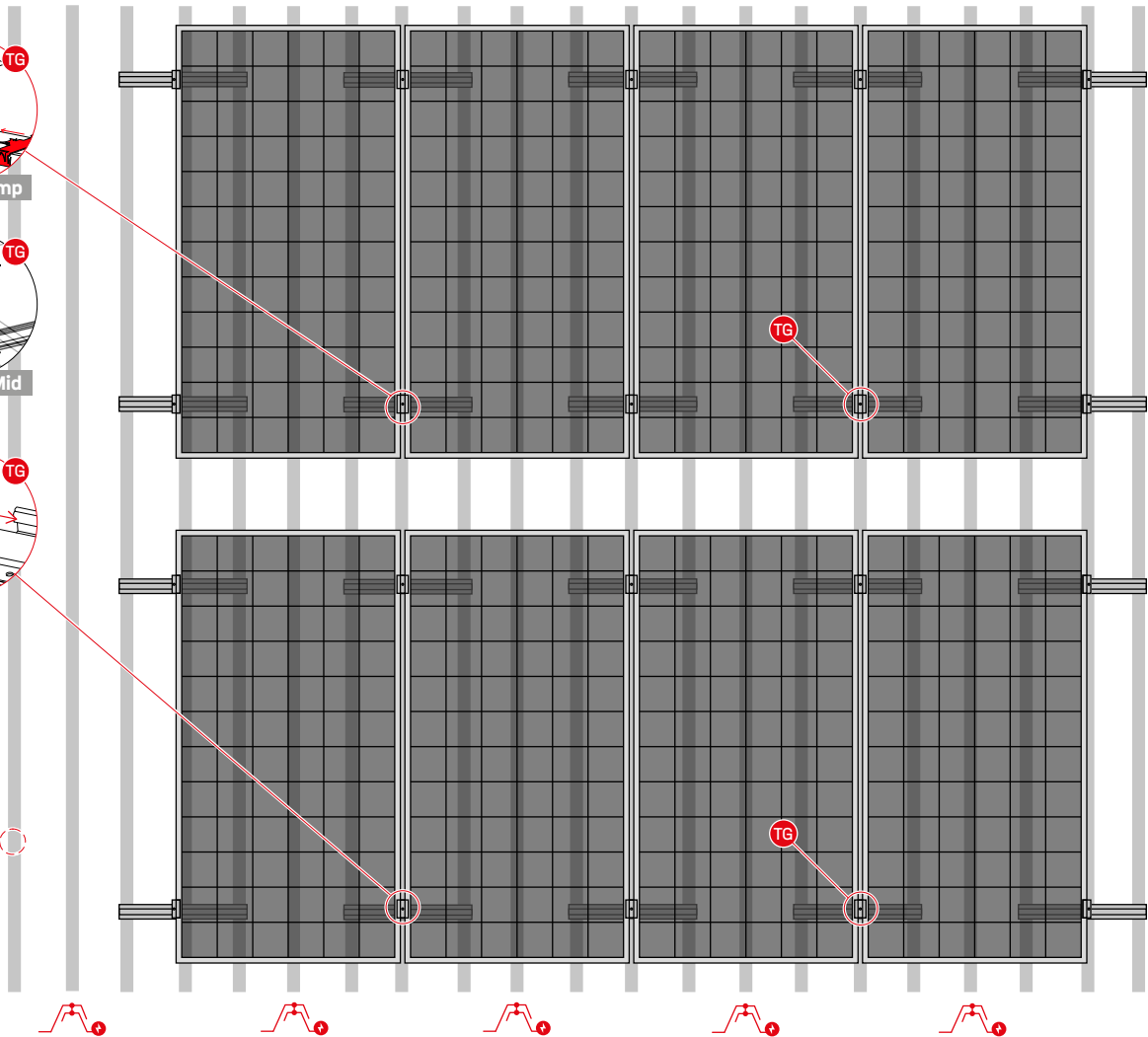

The trapezoidal sheets must be conductively connected to each other!

(A) Connection of the equipotential bonding cable as alternative lightning protection

Lightning protection and equipotential bonding

- The potential equalisation of the MiniRail MK2 is ensured via the trapezoidal sheet metal.
- Equipotential bonding to MiniFive is provided via TerraGrif PL.
- A TerraGrif PL Pro MiniFive Front and MiniFive End is required.
- The module frame earthing is done as required.
- For a connection to the lightning protection, all MiniRail sets may have to be connected so that they are capable of carrying lightning current. In this case, we recommend keeping the separation distance to the existing lightning protection!
- When using the K2 Clamp, you need the TerraGrif QL. When using the universal and standard clamps, you need TerraGrif K2SZ.

Materials needed:

If necessary TerraGrif K2SZ/
TerraGrif QL and TerraGrif PL

Trapezoidal metal sheet roof covers with MultiRail and MultiRail CSM

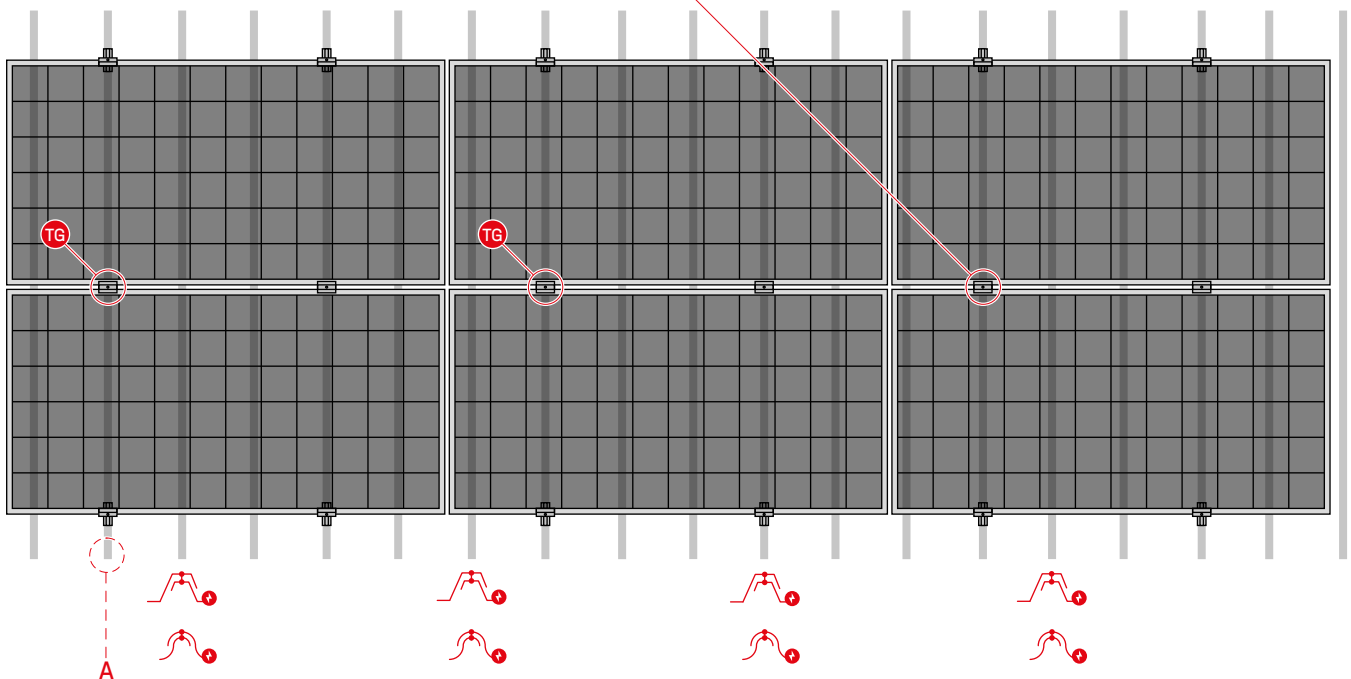
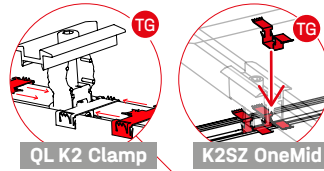
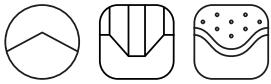

The trapezoidal/corrugated sheets must be conductively connected to each other!

(A) Connection of the equipotential bonding cable as alternative lightning protection

Lightning protection and equipotential bonding

- The drill holes in the MultiRail have been chosen in such a way that the screws in the set will inevitably work their way into the aluminium to such an extent that an electrical connection is created between the sheet metal and the MultiRail.
- We therefore recommend providing the trapezoidal or corrugated sheet metal tracks with equipotential bonding. Make sure that the individual sheet metal profiles are also electrically connected to each other.
- In this way, equipotential bonding is guaranteed via the trapezoidal/corrugated sheet.
- This applies to all MultiRail systems, CSM, RailUp, elevated and cross-connected systems.
- For a connection to the lightning protection, all MultiRail sets may have to be connected so that they are capable of carrying lightning currents. In this case, we recommend maintaining the separation distance to the existing lightning protection!
- The use of TerraGrif according to the illustration is based on the need for module frame earthing.
- When using the K2 Clamp, you need the TerraGrif QL. When using the universal and standard clamps, you need TerraGrif K2SZ.

Materials needed:

If necessary TerraGrif K2SZ/
TerraGrif QL

Standing seam roof covers

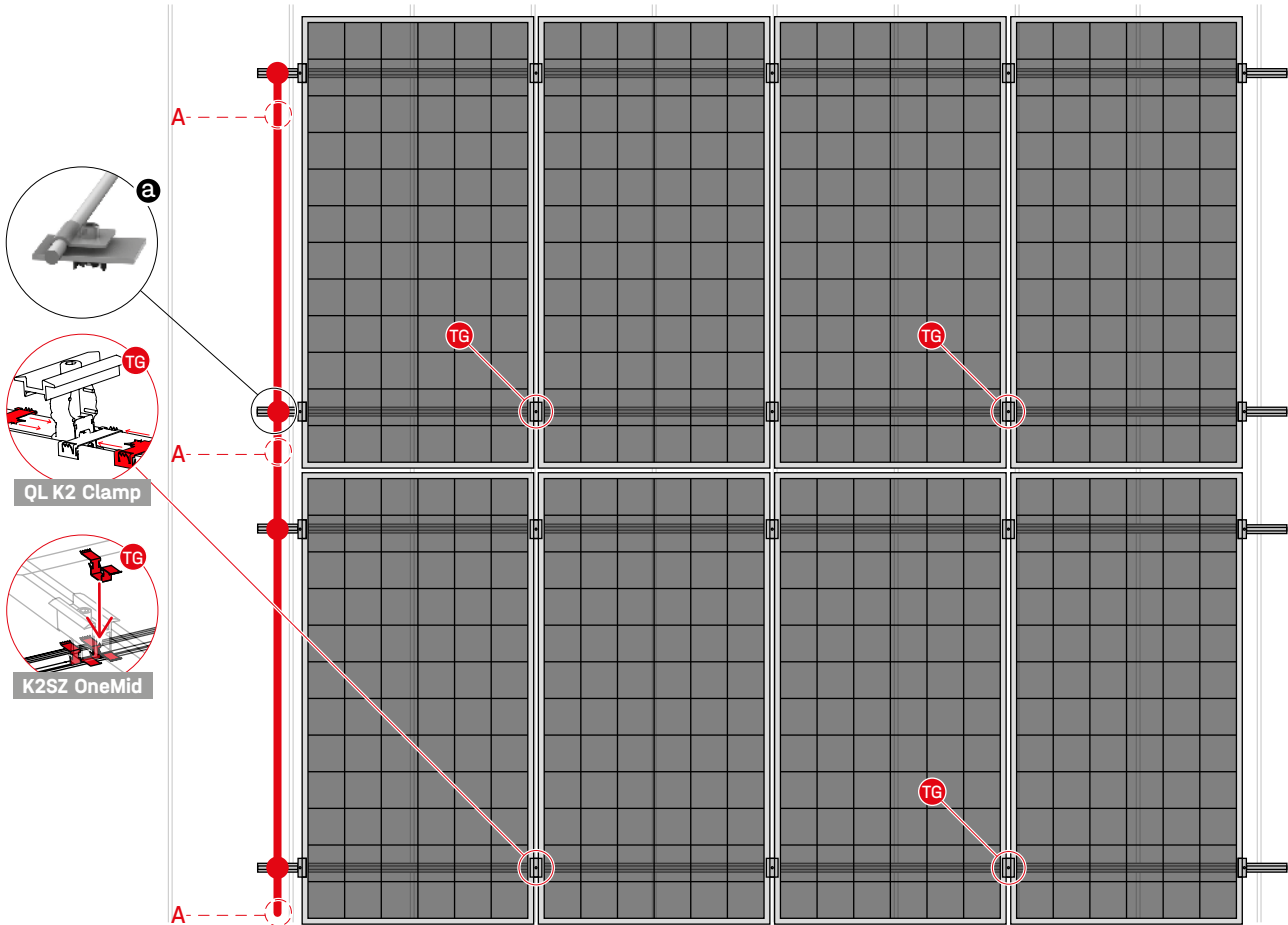
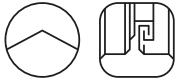

Lightning protection and equipotential bonding

- With sheet metal seam roofs, an electrical connection via the roof sheet cannot be guaranteed. Too many sheet metal types are surface-coated.
- We recommend connecting the rails per module block with an aluminium round wire ($\geq 16 \text{ mm}^2$).
- The connection with lightning protection clamp and aluminium round wire can be made capable of carrying lightning current if required ($\geq 25 \text{ mm}^2$ aluminium round wire).
- The individual module blocks can be connected to each other in the same way.
- The use of TerraGrif according to the illustration is carried out according to the need for module frame earthing.
- If module frame earthing is mandatory, you need one TerraGrif per module.
- When using the K2 Clamp, you need the TerraGrif QL. When using the universal and standard clamps, you need TerraGrif K2SZ.

Materials needed:

- **K2 Lightning protection clamp multi Alu 8 mm Set** consists of:
 - Lightning protection clamp Multi
 - Slot nut, stainless steel, PA
 - Allen Bolt M8 x 30
 - Washer 8,4x20x1,2 mm
- **Round wire**
- **K2 Underlay plate**
- **If necessary TerraGrif K2SZ/ TerraGrif QL**

Flat roofs

General notes

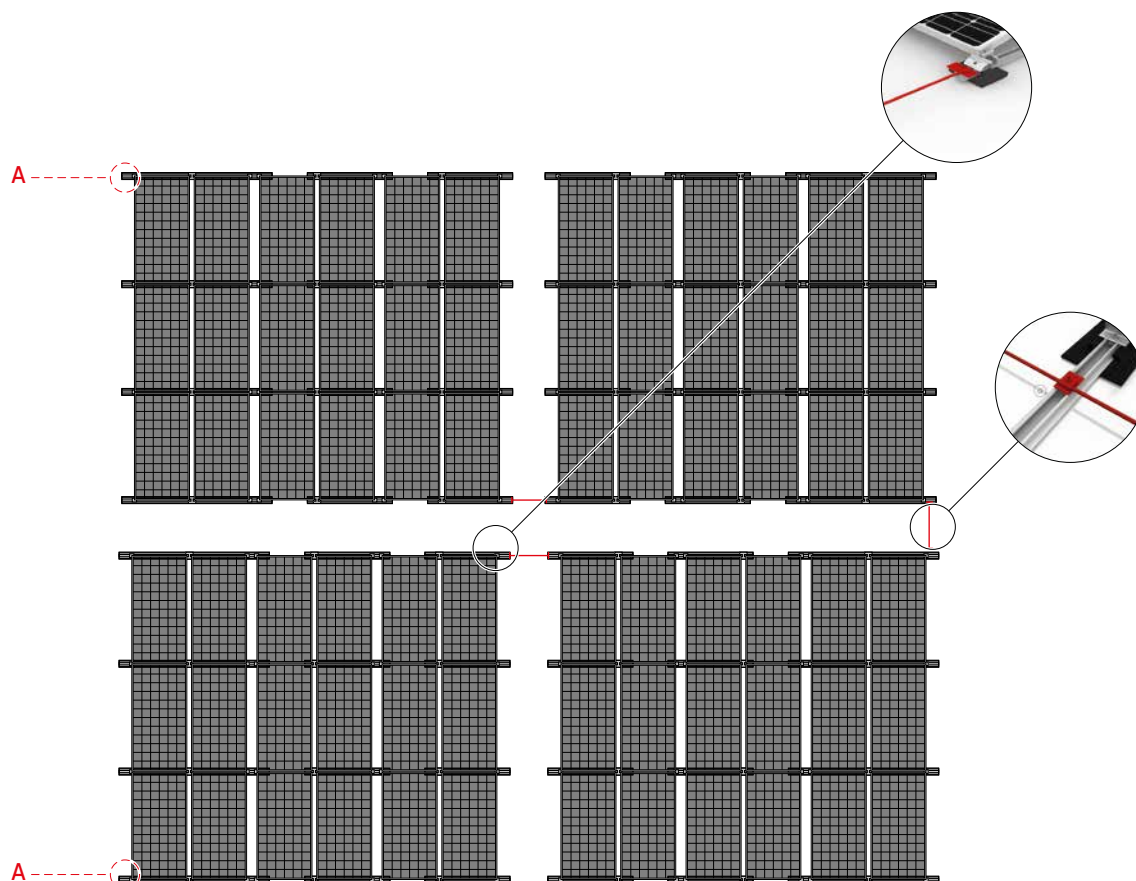

- We recommend using round aluminium wire for the connection to individual module blocks and the connection between each other.
- The connection (A) shows the possible connection point on the building's equipotential bonding!

S-Dome 6 Xpress: Equipotential bonding



The example shows the equipotential bonding of the mounting system in module direction via the windbreaker, alternatively with aluminium round wire in rail direction with TerraGrif PL and of the module frame with TerraGrif K2MI.

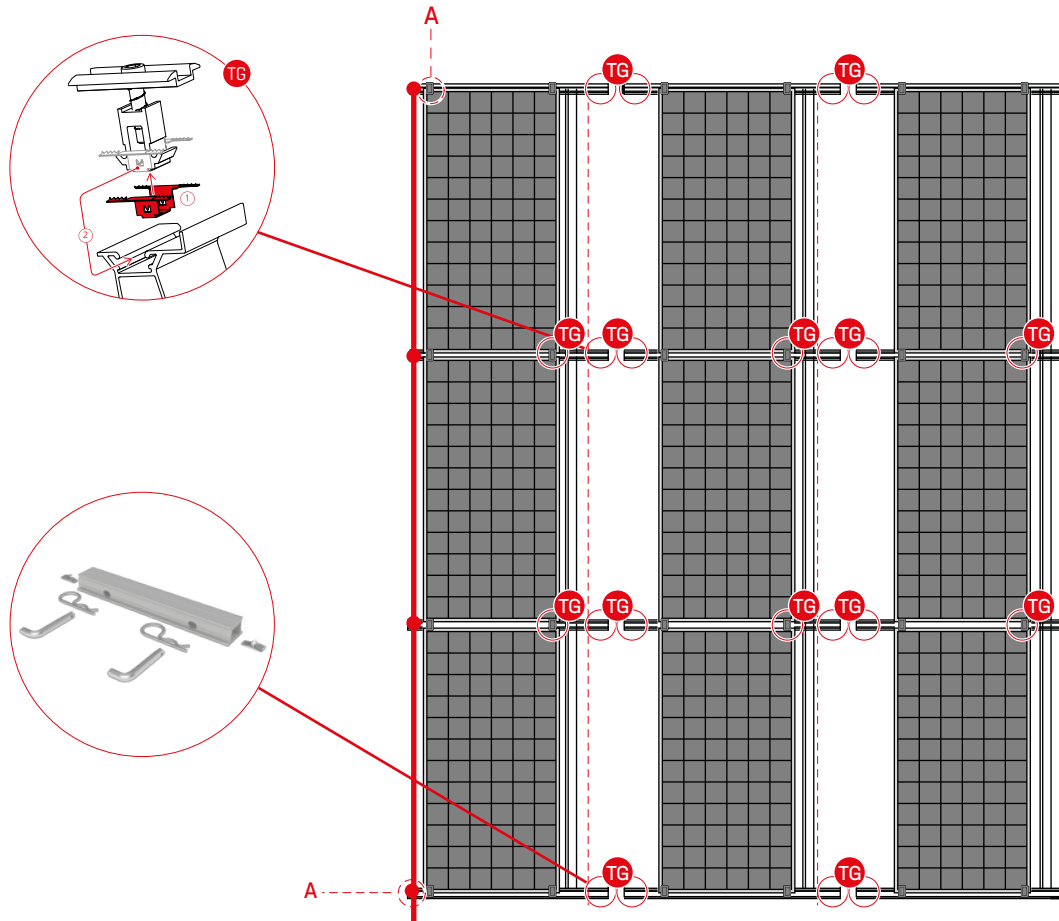

- Equipotential bonding in the direction of the module is ensured via the windbreaker/wind deflector sheet. Alternatively, earthing in module direction can be established with aluminium round wire.
- For equipotential bonding in the rail direction, we recommend using two TerraGrifs PL per rail connector. The TerraGrif PL are included in the set of the rail connector!
- Module frame earthing is carried out as required. If required, each module must be connected using TerraGrif K2 MI. For module frame earthing, we recommend a factor of 0.8 to 1 TerraGrif/module.

Materials needed:

- **K2 Lightning protection clamp multi Alu 8 mm Set** consists of:
 - Lightning protection clamp Multi
 - Slot nut, stainless steel, PA
 - Allen Bolt M8 x 30
 - Washer 8,4×20×1,2 mm
- **Round wire**
- **K2 Underlay plate**
- **TerraGrif PL**
- **TerraGrif K2MI**

S-Dome 6 Xpress: Lightning protection



The example shows a potential equalisation of the mounting system in module direction via the Windbreaker, alternatively with aluminium round wire in rail direction with TerraGrif PL.

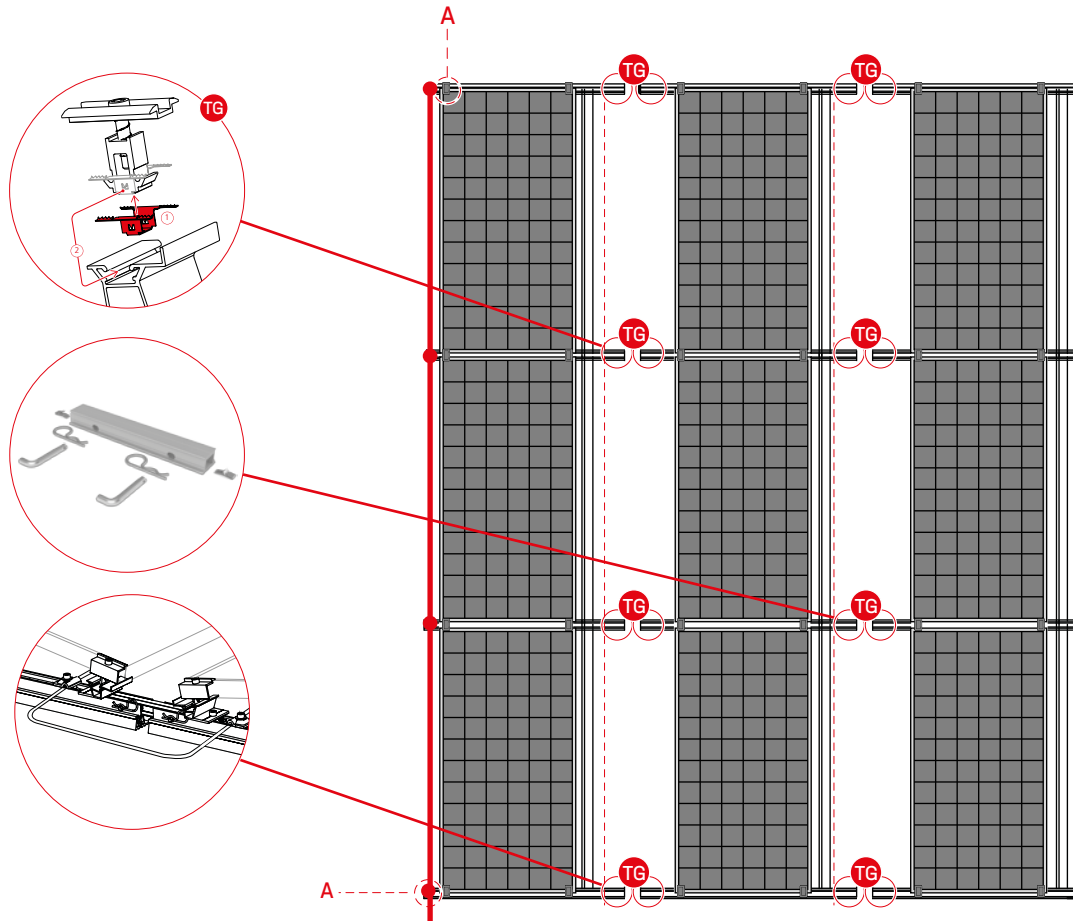

- If the system is to be integrated into an existing lightning protection system, lightning current carrying connections to the mounting system must be made. The connections within a block do not have to be designed to carry lightning current if the external building lightning protection is functioning.
- The planning for integrating the system into the existing external lightning protection and thus also the number of connections to the external lightning protection must be carried out by a lightning protection specialist. We recommend connecting and disconnecting with aluminium round wire ($\geq 25 \text{ mm}^2$).
- If the system must be set up to be capable of carrying lightning current, the rail connector must also be bridged with an aluminium round wire.
- Alternatively, we recommend maintaining the separation distance or using Dome 6.10 Classic.
- In addition to the lightning protection, the potential equalisation of all components must be set up.

Materials needed:

- **K2 Lightning protection clamp multi Alu 8 mm Set** consists of:
 - Lightning protection clamp Multi
 - Slot nut, stainless steel, PA
 - Allen Bolt M8 x 30
 - Washer 8,4×20×1,2 mm
- **Round wire**
- **K2 Underlay plate**
- **TerraGrif K2MI**
- **TerraGrif PL**

D-Dome 6 Xpress: Equipotential bonding



The example shows the equipotential bonding of the mounting system in module direction with aluminium round wire and the alternative with TerraGrif K2MI as well as in rail direction with TerraGrif PL.

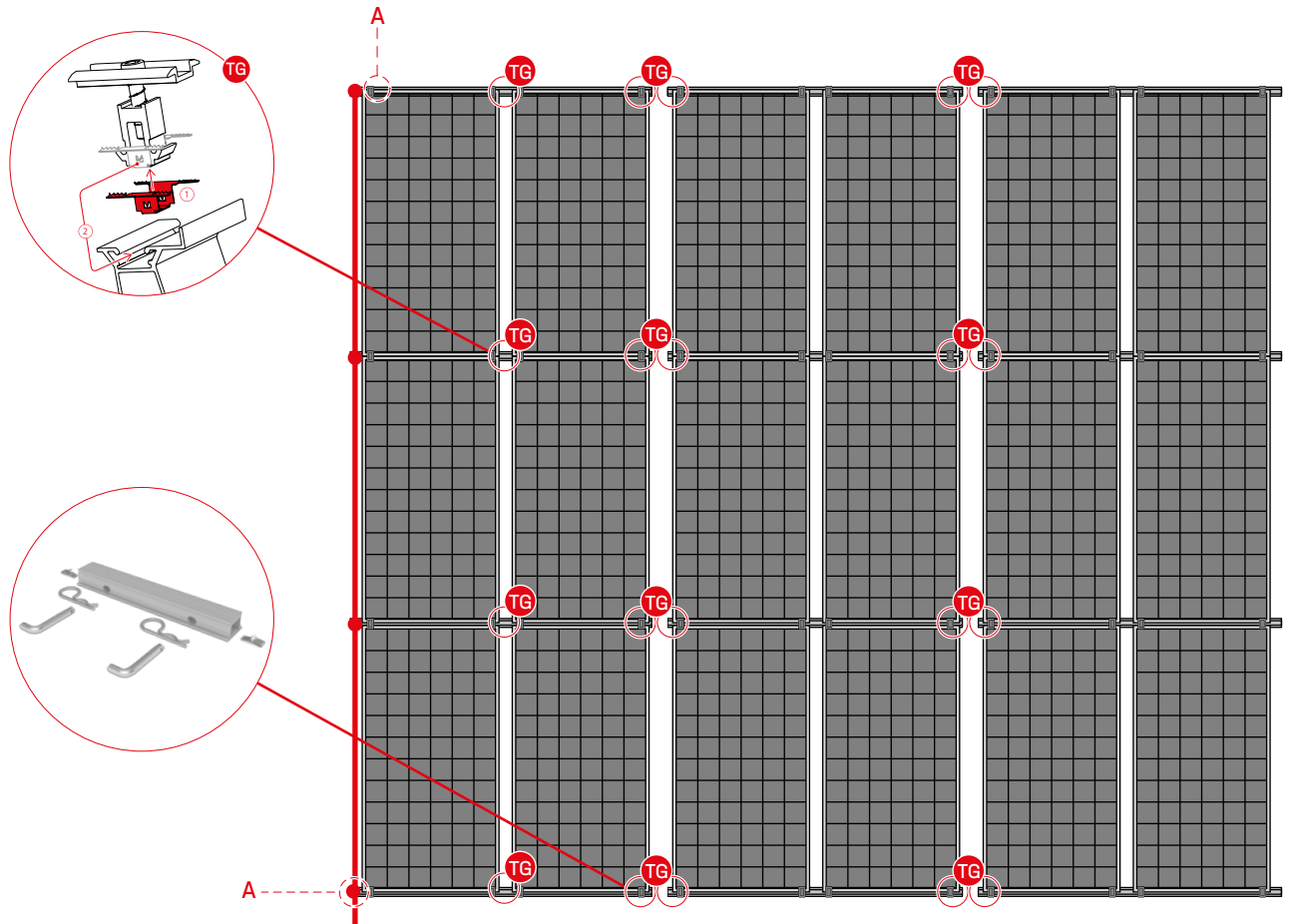

- For equipotential bonding in the direction of the module, we recommend making a connection with aluminium round wire. Alternatively, a connection can be made via the module frame with TerraGrif K2MI.
- For equipotential bonding in rail direction, we recommend using two TerraGrifs PL per rail connector. The TerraGrif PL are included in the set of the rail connector!
- Module frame earthing is carried out as required. If required, each module must be connected using TerraGrif K2 MI. For module frame earthing, we recommend a factor of 0.8 to 1 TerraGrif/module.
- The factor changes if the equipotential bonding of the mounting system is also established with TerraGrif K2MI.

Materials needed:

- **K2 Lightning protection clamp multi Alu 8 mm Set** consists of:
 - Lightning protection clamp Multi
 - Slot nut, stainless steel, PA
 - Allen Bolt M8 x 30
 - Washer 8,4×20×1,2 mm
- **Round wire**
- **K2 Underlay plate**
- **TerraGrif PL**
- **TerraGrif K2MI**

D-Dome 6 Xpress: Lightning protection



The example shows the equipotential bonding of the mounting system in module direction with aluminium round wire, in rail direction with TerraGrif PL and of the module frame with TerraGrif K2MI.

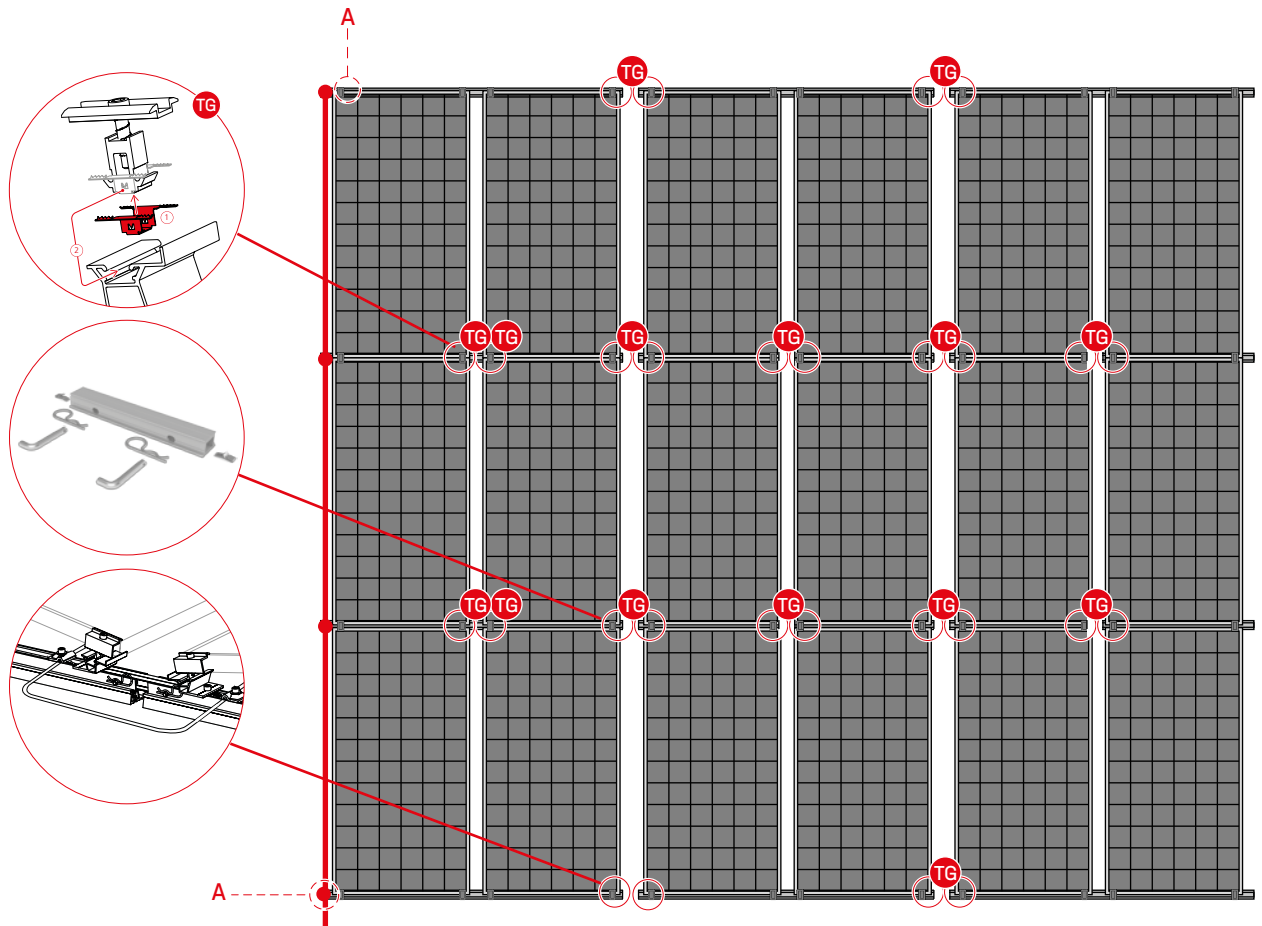

- If the system is to be integrated into an existing lightning protection system, lightning current carrying connections to the mounting system must be made. The connections within a block do not have to be designed to carry lightning current if the external building lightning protection is functioning.
- The planning for integrating the system into the existing external lightning protection and thus also the number of connections to the external lightning protection must be carried out by a lightning protection specialist. We recommend connecting and disconnecting with aluminium round wire ($\geq 25\text{mm}^2$).
- If the system must be set up to carry lightning current, the rail connector must also be bridged with an aluminium round wire.
- Alternatively, we recommend maintaining the separation distance or using Dome 6.10 Classic.
- In addition to the lightning protection, the potential equalisation of all components must be set up.

Materials needed:

- **K2 Lightning protection clamp multi Alu 8 mm Set** consists of:
 - Lightning protection clamp Multi
 - Slot nut, stainless steel, PA
 - Allen Bolt M8 x 30
 - Washer 8,4x20x1,2 mm
- **Round wire**
- **K2 Underlay plate**
- **TerraGrif K2MI**
- **TerraGrif PL**

S-Dome 6 Classic: Potential equalisation and lightning protection



The example shows a lightning protection equipotential bonding of the mounting system in module direction via the windbreakers, alternatively with aluminium round wire and the module frame earthing with K2MI.

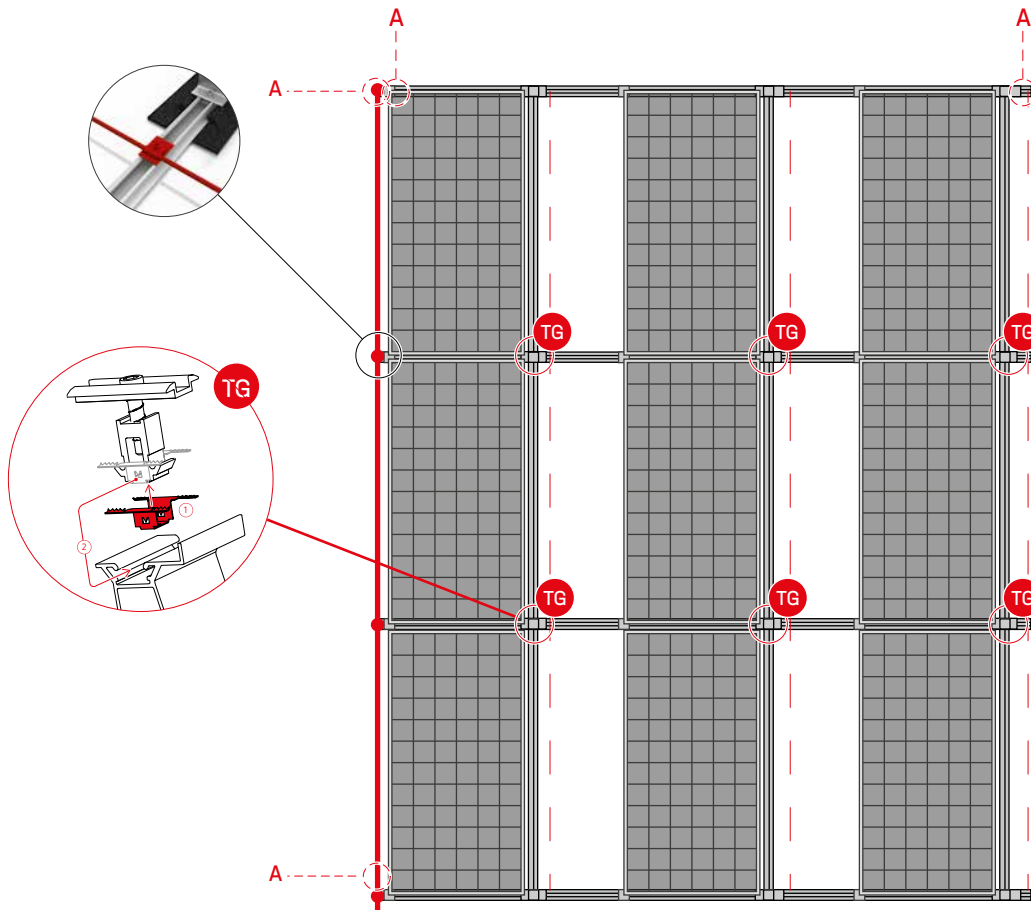

- The mounting system is capable of carrying lightning current without additional connections.
- A (lightning protection) equipotential bonding in module direction is carried out via the windbreaker/wind deflector plates.
- Alternatively, equipotential bonding can be established with aluminium round wire.
- If the system is to be integrated into an existing lightning protection system, lightning current-carrying connections must be made to the mounting system.
- We recommend an aluminium round wire ($\geq 25 \text{ mm}^2$) for the connection and discharge to a lightning protection.
- In case of gaps in the module layout, make sure that all modules are integrated in the equipotential bonding or lightning protection.
- The planning for integrating the system into the lightning protection and thus the number of connections to the external lightning protection must be carried out by a lightning protection specialist.
- Module frame earthing is carried out as required. We recommend using a TerraGrif K2MI/module.
- For this, we recommend a factor of 0.8 TerraGrif/module.

Materials needed:

- **K2 Lightning protection clamp multi Alu 8 mm Set** consists of:
 - Lightning protection clamp Multi
 - Slot nut, stainless steel, PA
 - Allen Bolt M8 x 30
 - Washer 8,4x20x1,2 mm
- **Round wire**
- **K2 Underlay plate**
- **TerraGrif K2MI**

D-Dome 6 Classic: Potential equalisation and lightning protection



The example shows a lightning protection equipotential bonding of the mounting system in module direction with aluminium round wire and the module frame earthing with K2MI

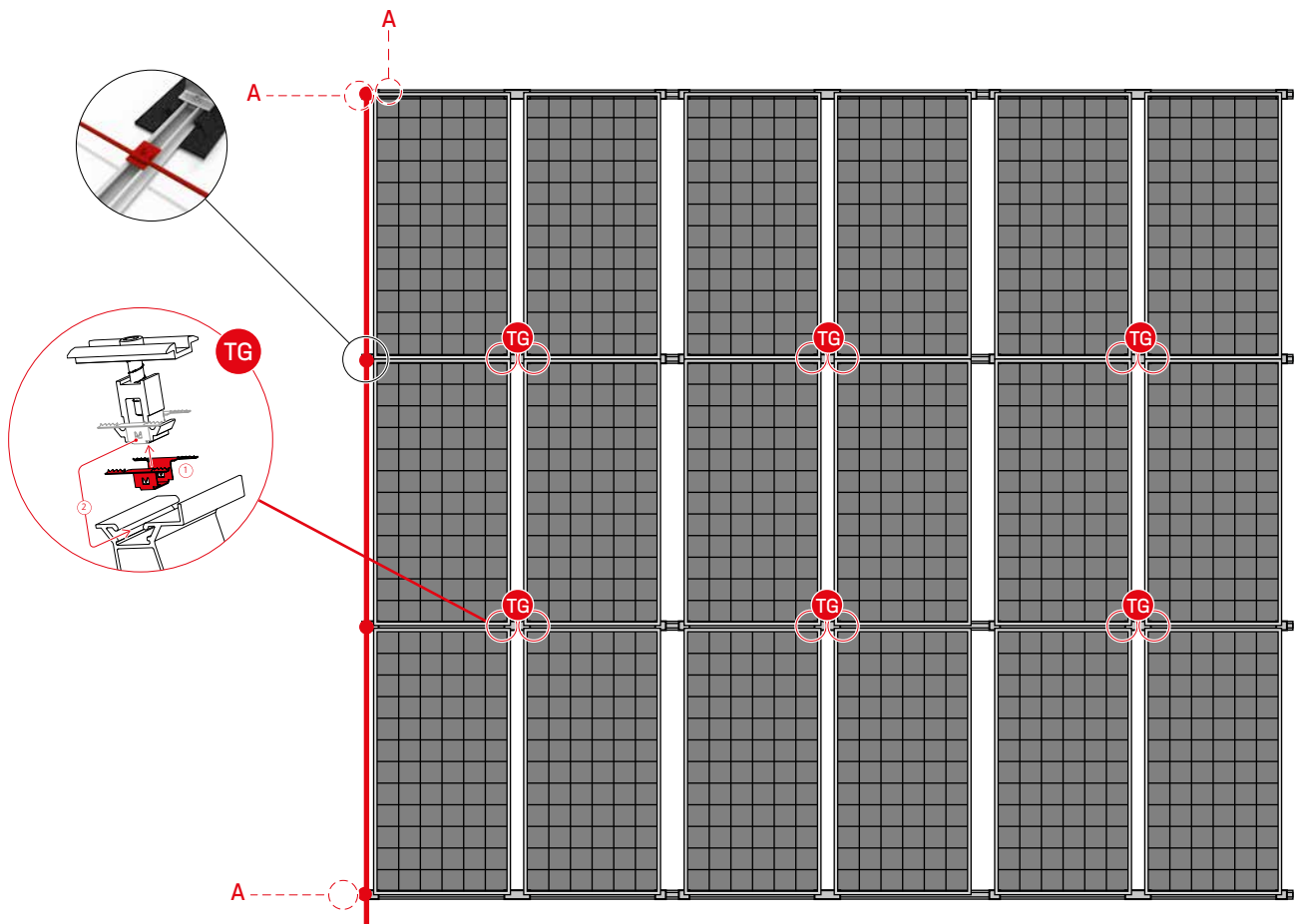

- The mounting system is capable of carrying lightning current without additional connections.
- The (lightning protection) equipotential bonding in the module direction is carried out with aluminium round wire.
- The planning for integrating the system into the existing external lightning protection and thus the number of connections to the external lightning protection must be carried out by a lightning protection specialist. We recommend connecting and disconnecting with aluminium round wire ($\geq 25\text{mm}^2$).
- In addition to the lightning protection, the potential equalisation of all components must be established. We recommend setting up the potential equalisation with aluminium round wire, alternatively with TerraGrif K2 MI.
- In case of gaps in the module layout, make sure that all modules are integrated in the equipotential bonding or lightning protection.
- Module frame earthing is carried out as required. We recommend using a TerraGrif K2MI. You need a factor of 0.8 TerraGrif/module.

Materials needed:

- **K2 Lightning protection clamp multi Alu 8 mm Set** consists of:
 - Lightning protection clamp Multi
 - Slot nut, stainless steel, PA
 - Allen Bolt M8 x 30
 - Washer 8,4x20x1,2 mm
- **Round wire**
- **K2 Underlay plate**
- **TerraGrif K2MI**

S-Dome 6 Classic LS: Potential equalisation and lightning protection



The example shows the equipotential bonding of the mounting system in module direction via the windbreaker and the cross bracing, alternatively with aluminium round wire on the outer rails and the module frame with TerraGrif K2MI.

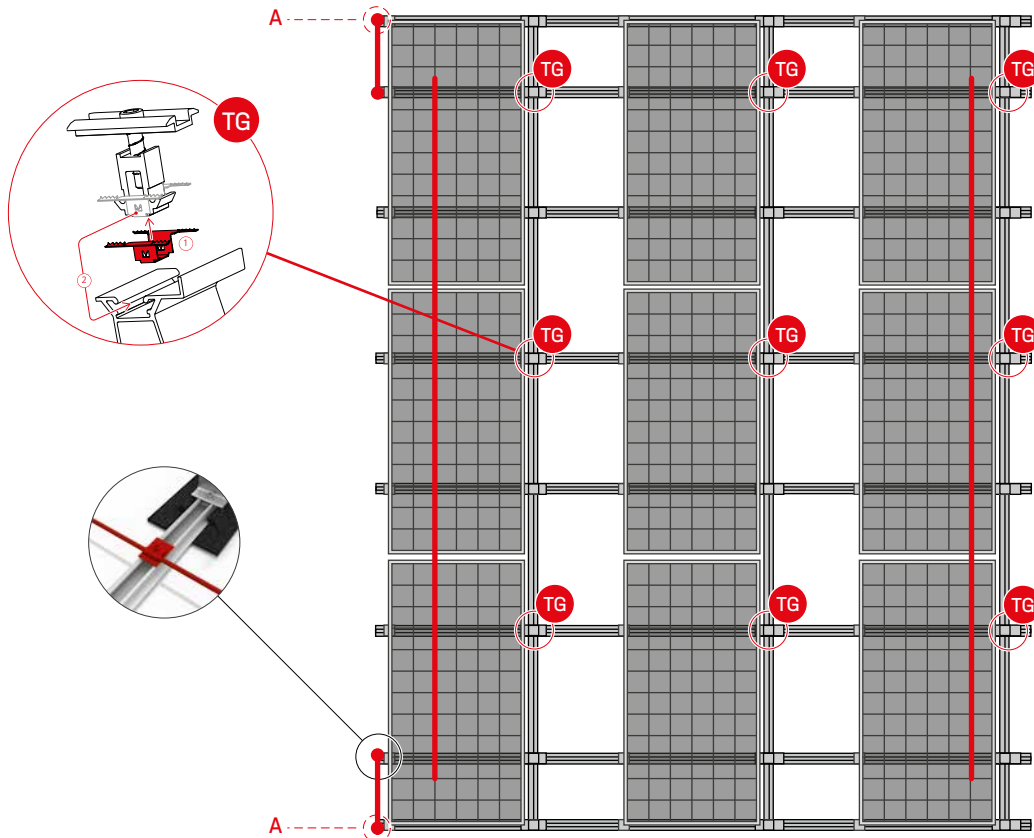

- Equipotential bonding in the direction of the module is ensured via the windbreaker/ wind deflector sheet.
- the wind deflector plate, as well as via the cross bracing. Alternatively, the edge rails can be earthed in the direction of the module with aluminium round wire.
- The module frame earthing is carried out if required. If required, each module must be connected using TerraGrif K2MI. For module frame earthing, we recommend a factor of 1 TerraGrif/module.
- The planning for integrating the system into the existing external lightning protection and thus the number of connections to the external lightning protection must be carried out by a lightning protection specialist.
- If the system is to be integrated into an existing lightning protection system, lightning current-carrying connections to the mounting system must be made. We recommend connecting and disconnecting with aluminium round wire ($\geq 25 \text{ mm}^2$).
- In addition to the lightning protection, the potential equalisation of all components must always be established.

Materials needed:

- **K2 Lightning protection clamp multi Alu 8 mm Set** consists of:
 - Lightning protection clamp Multi
 - Slot nut, stainless steel, PA
 - Allen Bolt M8 x 30
 - Washer 8,4×20×1,2 mm
- **Round wire**
- **K2 Underlay plate**
- **TerraGrif K2MI**

D-Dome 6 Classic LS: Potential equalisation and lightning protection



The example shows the equipotential bonding of the mounting system in module direction via the cross bracing and the module frame with TerraGrif K2MI.

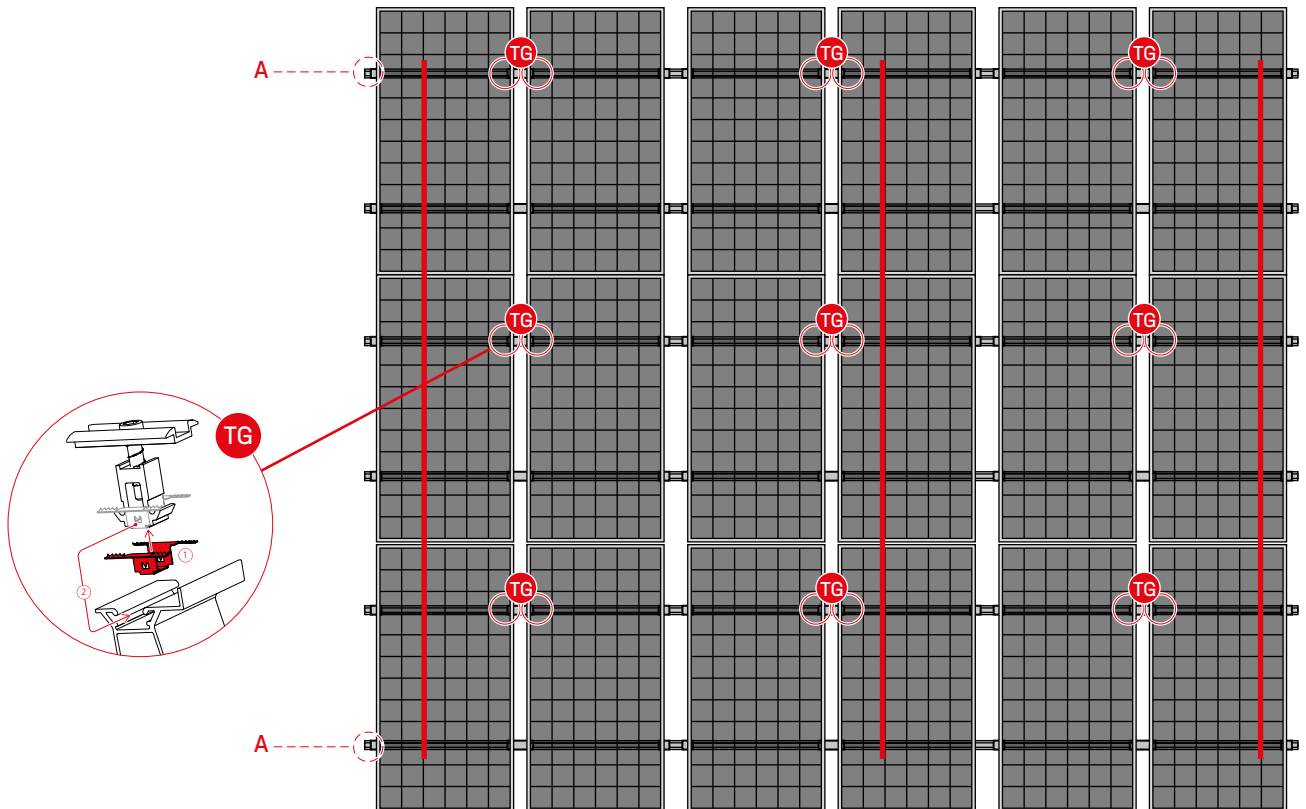

- Equipotential bonding in the direction of the module is ensured via the cross bracing.
- The module frame earthing is carried out if required. If required, each module must be connected using TerraGrif K2MI. For module frame earthing, we recommend a factor of 1 TerraGrif/module.
- The planning for integrating the system into the existing external lightning protection and thus the number of connections to the external lightning protection must be carried out by a lightning protection specialist.
- If the system is to be integrated into an existing lightning protection system, lightning current-carrying connections to the mounting system must be made. We recommend connecting and disconnecting with aluminium round wire ($\geq 25 \text{ mm}^2$).
- In addition to the lightning protection, the potential equalisation of all components must always be established.

Materials needed:

- **K2 Lightning protection clamp multi Alu 8 mm Set** consists of:
 - Lightning protection clamp Multi
 - Slot nut, stainless steel, PA
 - Allen Bolt M8 x 30
 - Washer 8,4x20x1,2 mm
- **Round wire**
- **K2 Underlay plate**
- **TerraGrif K2MI**

K2 lightning protection elements

for aluminium round wire 8 mm

K2 Lightning protection clamp multi Alu 8 mm Set consists of:

- Lightning protection clamp Multi
- Slot nut, stainless steel, PA
- Allen Bolt M8 x 30
- Washer 8,4×20×1,2 mm

optional: K2 Underlay plate

Sheet material: Aluminium

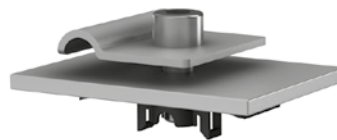

2002473

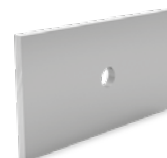

1000789

General notes

Different components are needed to connect the mounting system to existing lightning protection. We recommend using suitable components for the lightning protection as required. The connections must be permanently suitable when connecting different materials, taking account of the electrochemical voltage series:

- Cross connections
- Parallel connections
- Connections



k2-systems.com

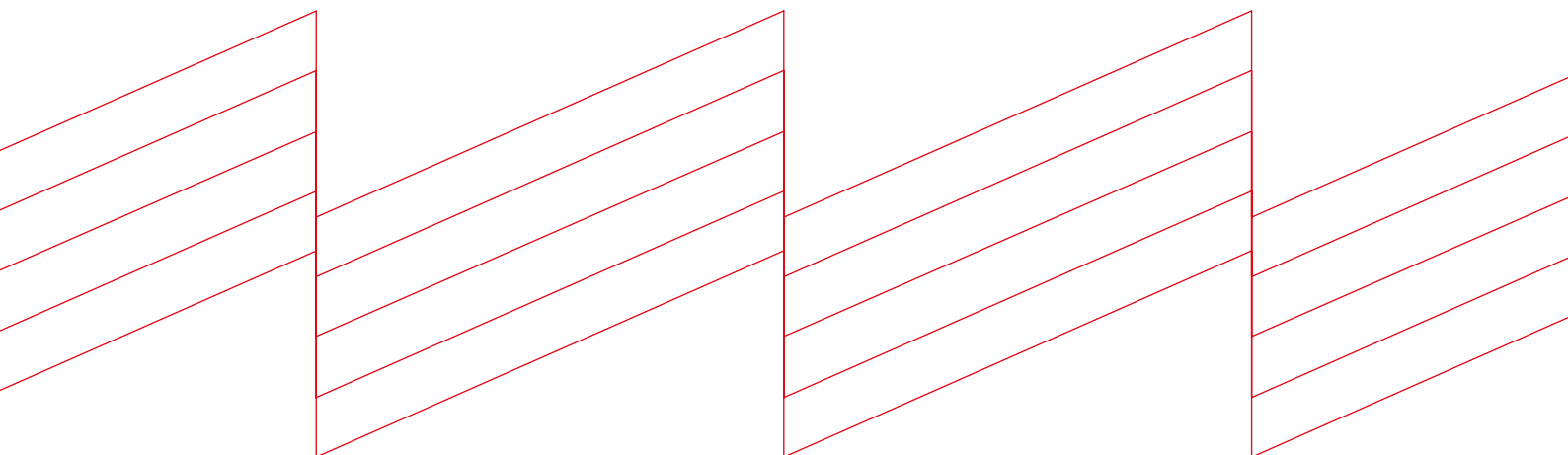

K2 Systems GmbH

Industriestraße 18 · 71272 Renningen · Germany
+49 (0) 7159 - 42059 - 0 · info@k2-systems.com

Equipotential bonding and lightning protection manual EN V6 | 0423 · Subject to change without notice
Images of the products are exemplary and may differ from the original.